

LEVEL 6
TESTS

ANSWER
BOOKLET

MATHEMATICS TEST

LEVEL 6 TESTS

Ma

Paper 2 – calculator allowed

| | | | |
|-------------------|-----|-------|------|
| First name | | | |
| Middle name | | | |
| Last name | | | |
| Date of birth | Day | Month | Year |
| Please circle one | Boy | Girl | |
| Year group | | | |
| School | | | |

YOU MAY NEED

- Pens, pencils and a rubber.
- A ruler.
- A pair of compasses.
- A protractor or angle measurer.
- Tracing paper.
- A mirror.
- A calculator.

REMEMBER

- You have 30 minutes to complete this test paper.
- Try to answer all the questions.
- Write all your answers and working on the test paper – do not use any rough paper. Marks may be awarded for working.
- Check your work carefully.
- Ask your teacher if you are not sure what to do.

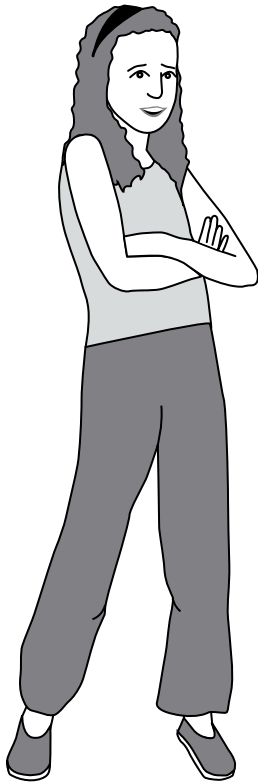

Lisa

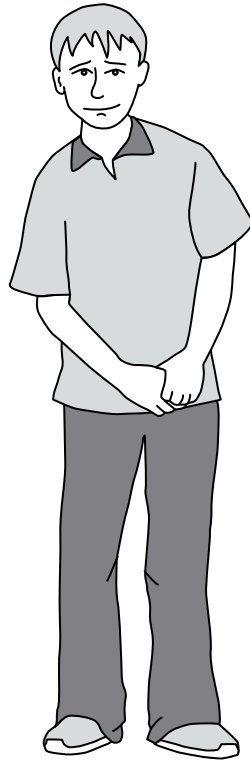

Nik

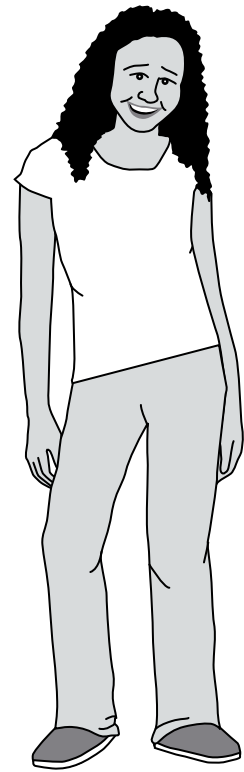

Kemi

You might need to use this formula.

Trapezium

$$\text{Area} = \frac{1}{2}(a + b)h$$

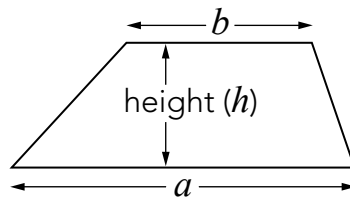

Instructions

You **may** use a calculator to answer any questions in this test paper.

- Work as quickly and as carefully as you can.
 - You have 30 minutes for this test paper.
 - If you cannot do one of the questions, **go on to the next one**. You can come back to it later, if you have time.
 - If you finish before the end, **go back and check your work**.
-

Follow the instructions for each question carefully.



This shows where you need to put the answer.

If you need to do working out, you can use any space on a page.

Some questions have an answer box like this:

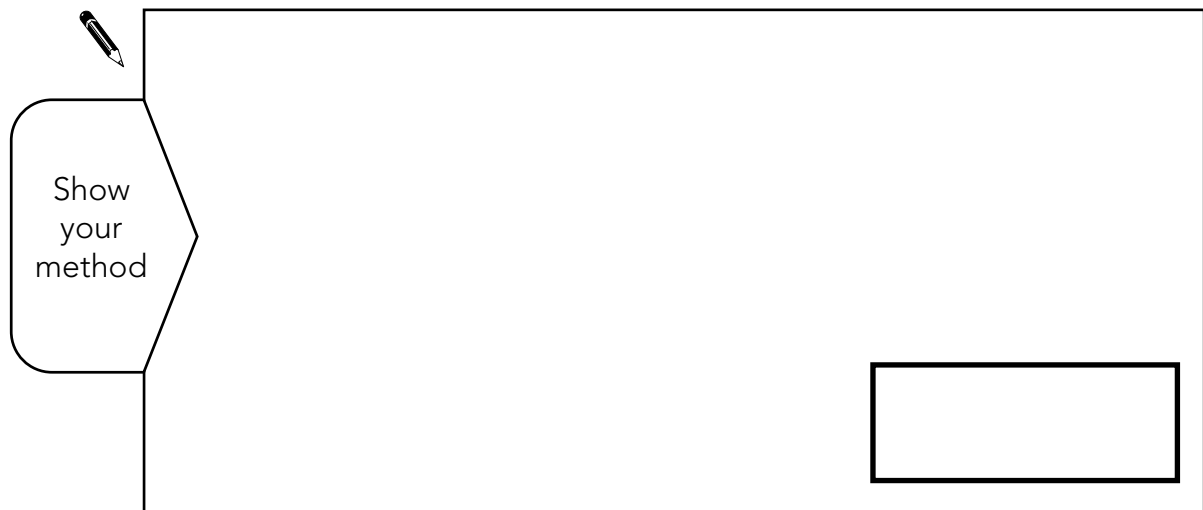

The diagram shows a large rectangular box representing a question area. On the left side, there is a callout box with a pencil icon and the text "Show your method". In the bottom right corner of the large box, there is a smaller, empty rectangular box representing an answer box.

For these questions you may get a mark for showing your method.

1

Here is a shaded triangle on a square grid.

Draw the new position of the triangle when it is **rotated 180°** about point A.

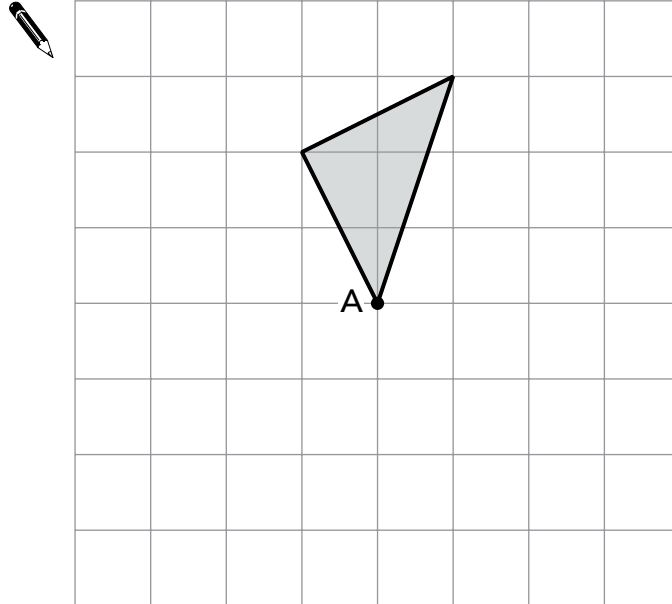

(1 mark)

2

The rule to get each number in a sequence is

subtract the previous number from 100, then **divide** the answer by 2

Here is part of the sequence.

Write the two missing numbers.



40 30 35 32.5 33.75

(2 marks)

3

Here are two spinners divided into equal parts.

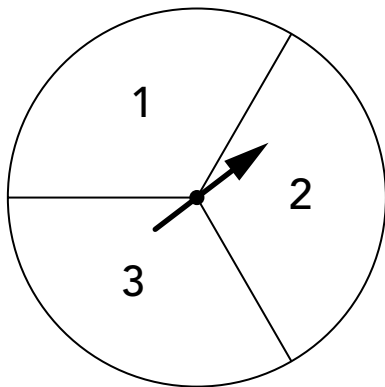

A

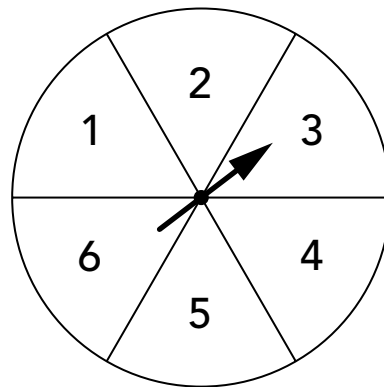

B

Kemi spins the pointers once to get a score on each spinner.

Put one tick (✓) in each row to complete the table below.

One row is done for you.

| | more likely on A | more likely on B | equally likely on A or B |
|--|-------------------------------------|--------------------------|-----------------------------|
| a score less than 4 | <input checked="" type="checkbox"/> | <input type="checkbox"/> | <input type="checkbox"/> |
|  an even number | <input type="checkbox"/> | <input type="checkbox"/> | <input type="checkbox"/> |
| a score of 2 | <input type="checkbox"/> | <input type="checkbox"/> | <input type="checkbox"/> |
| a score greater than 1 | <input type="checkbox"/> | <input type="checkbox"/> | <input type="checkbox"/> |

(2 marks)

4

A farmer has £1200 to buy apple trees and pear trees.

Apple trees cost £24.75 each.

Pear trees cost £12.50 each.



He buys 35 apple trees.

How many pear trees can he buy with the money he has left?



Show
your
method

(2 marks)

5

This table shows the number of things to eat in **five** children's lunch boxes.

| | sandwiches | apples | bananas | fruit bars |
|------|------------|--------|---------|------------|
| Lisa | 1 | 2 | 0 | 2 |
| Jack | 2 | 0 | 2 | 1 |
| Kemi | 1 | 1 | 0 | 2 |
| Nik | 1 | 2 | 1 | 0 |
| Ben | 2 | 1 | 2 | 1 |

Here is a graph of the information for **four** of the children.

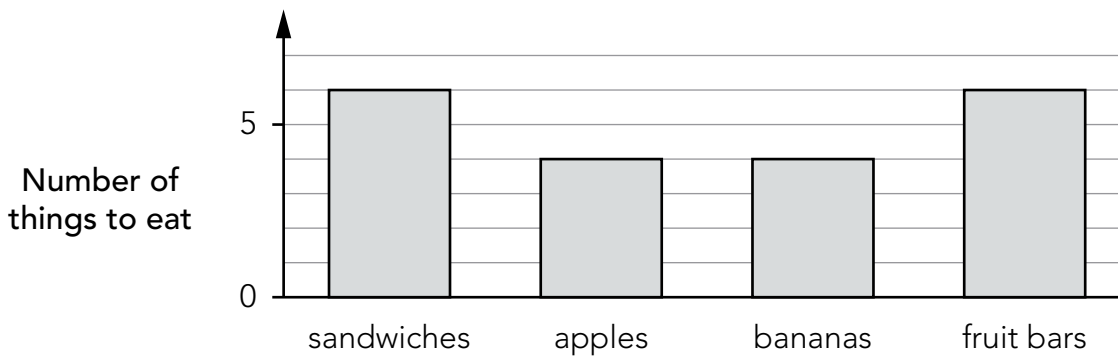

Which child's information is missing from the graph?



Explain how you know.



(1 mark)

6

The flag of Greenland is a rectangle with a circle drawn inside.

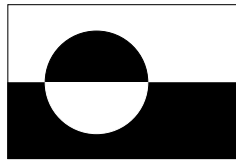

Here is the same flag rotated.

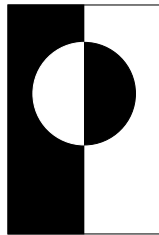

The sketch gives the information you need to draw the flag.

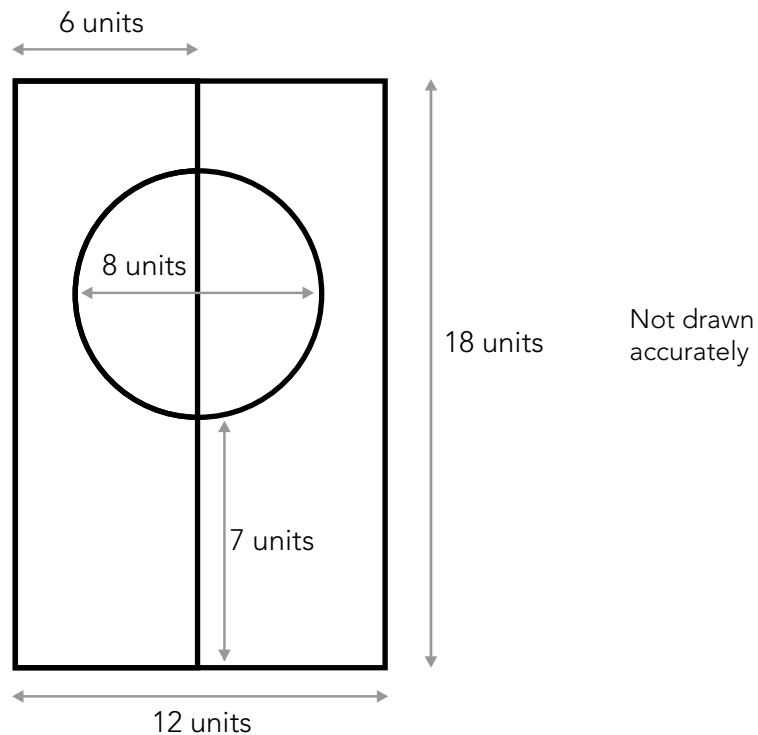

The question is on the next page.

Use the correct mathematical equipment to **draw accurately** the flag of Greenland.

Some of the flag is drawn for you.

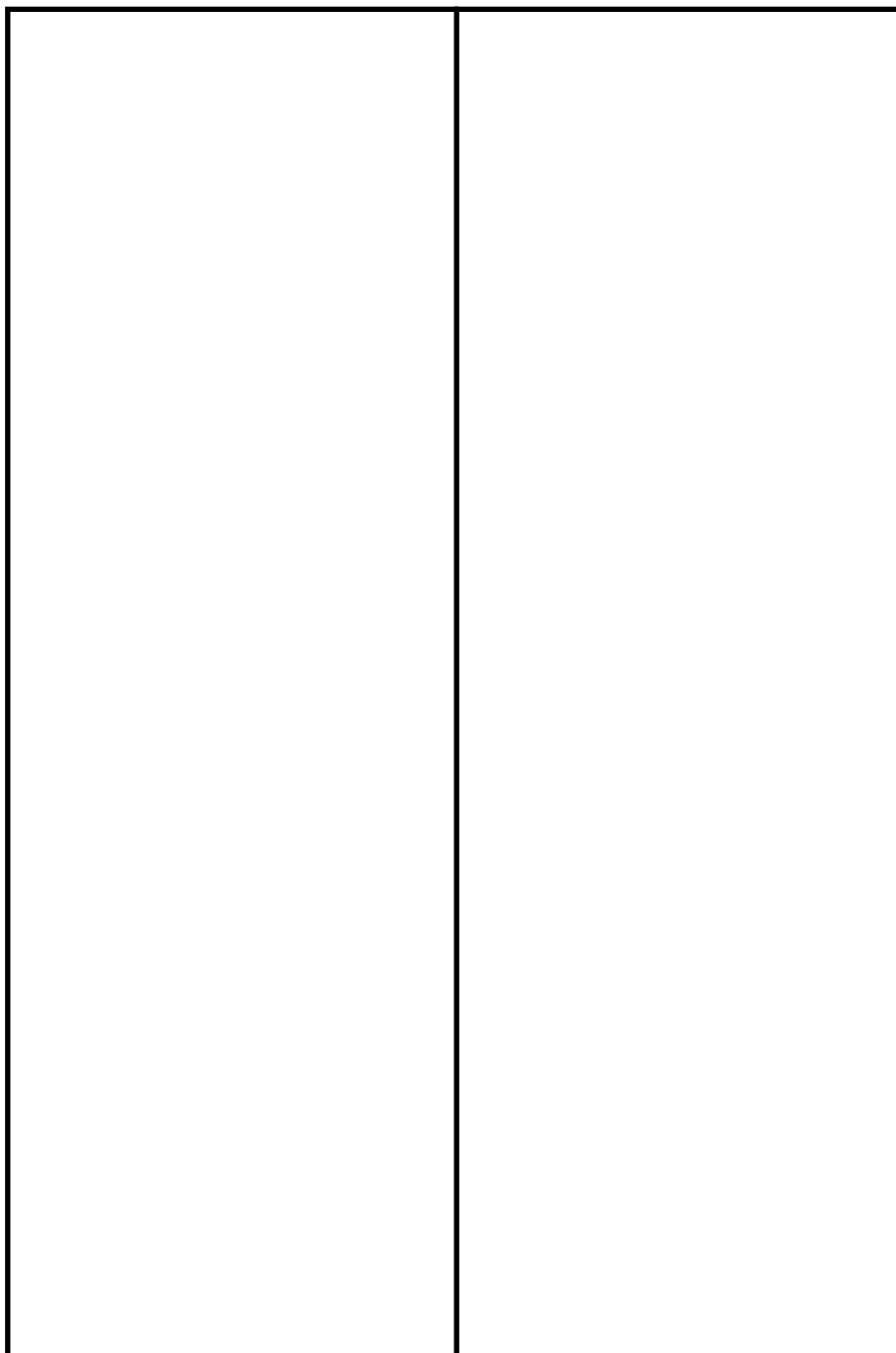

(3 marks)

7

The diagram shows a square of side length 12cm.

Inside the square are 8 congruent trapeziums and a shaded square.

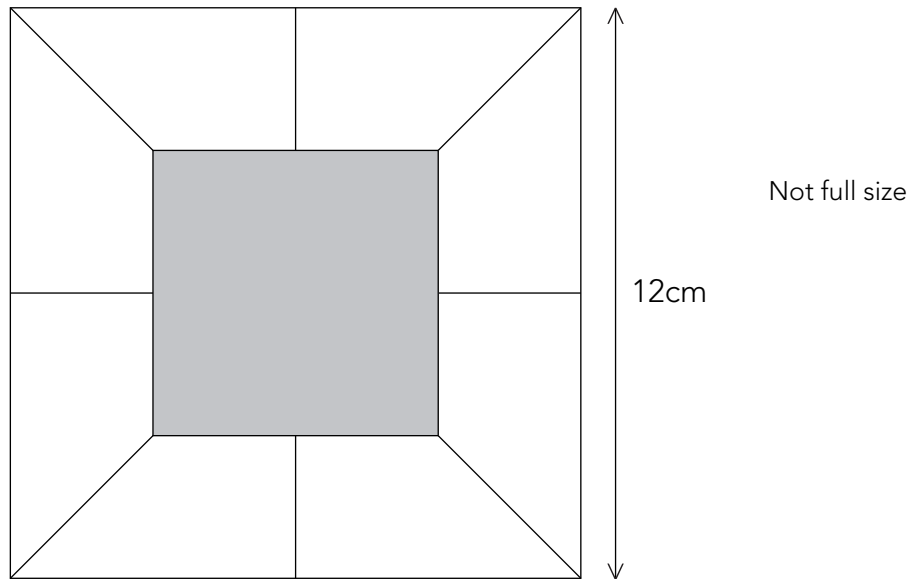

The **side length** of the shaded square is **6cm**.

What is the area of one of the trapeziums?



Show
your
method

cm²

(3 marks)

8

Work out the missing numbers below.

The first one is done for you.

The first multiples of add to 60

(because $4 + 8 + 12 + 16 + 20 = 60$)



The first multiples of add to 60

(1 mark)

Now use **different** numbers to complete the sentence below.



The first multiples of add to 60

(1 mark)

9

Here are three questions and answers about bananas.

On average, how much does each person pay for bananas in supermarkets?

Answer: **56p per kg**



On average, what quantity of bananas does each person eat in one year?

Answer: **10kg**

Who gets money from the sale of bananas?

Answer:

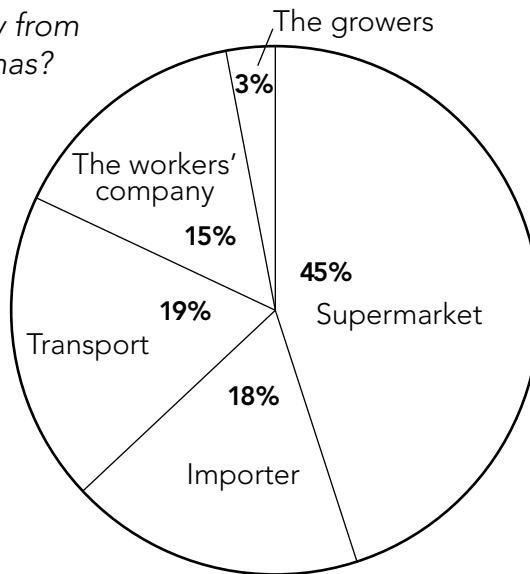

How much of the money each person pays for bananas in one year goes to the **growers**?



Show your method

p

(2 marks)

10

Lisa is using trial and improvement to find a solution to this equation.

$$x^2 - 3x = 1$$

Here are her first few trials.

Complete the missing information.



When $x = 3$, $x^2 - 3x = 0$, so this value of x is too small

When $x = 4$, $x^2 - 3x =$ _____, so this value of x is too _____ (1 mark)

When $x = 3.5$, $x^2 - 3x =$ _____, so this value of x is too _____ (1 mark)

What value of x should Lisa try next?



$x =$ _____

Explain why you chose that value.



(1 mark)

11

Nik uses this graph to change between pounds (£), dollars and euros.

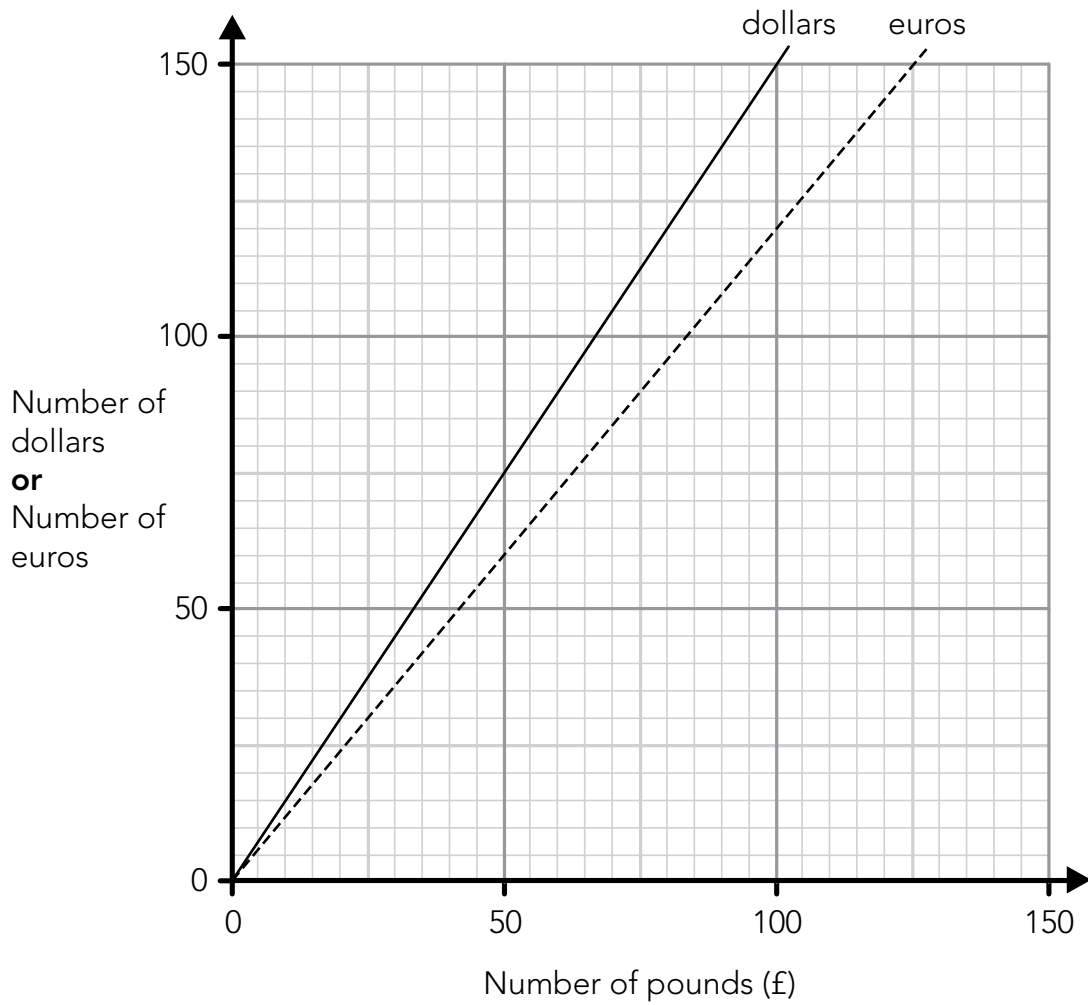

The questions are on the next page.

Use the graph to work out the missing numbers below.

The first one is done for you.

£70 is about the same as **84 euros**



£70 is about the same as _____ **dollars**

120 dollars is about the same as **£ _____**

(1 mark)

120 euros is about the same as _____ **dollars**

(1 mark)

12

Here are two pieces of information about dogs called German Shepherds.

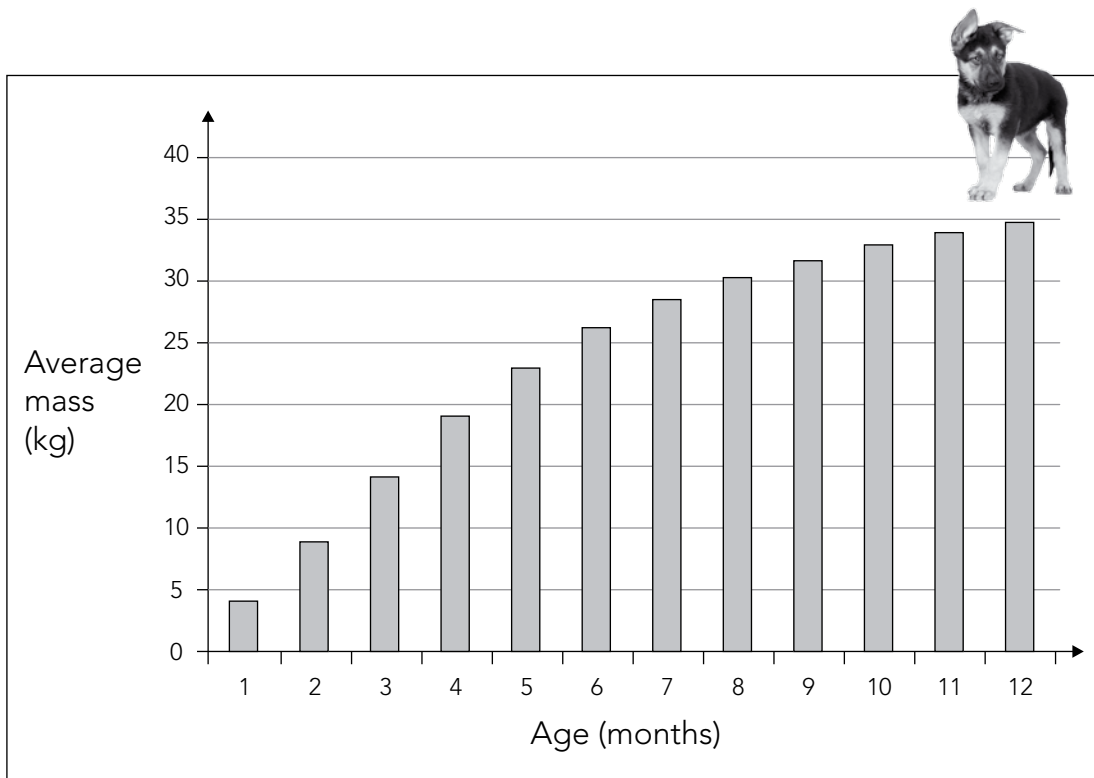

The average mass of an **adult** German Shepherd is about 35kg.

Use **both** pieces of information to summarise how German Shepherd dogs grow.



(2 marks)

END OF TEST

DO NOT WRITE ON THIS PAGE

DO NOT WRITE ON THIS PAGE

DO NOT WRITE ON THIS PAGE

QCDA/11/5453

Optional level 6 tests | Mathematics paper 2