

Centre Number						Candidate Number				
Surname										
Other Names										
Candidate Signature										

For Examiner's Use	
Examiner's Initials	
Pages	Mark
3	
4 – 5	
6 – 7	
8 – 9	
10 – 11	
12 – 13	
14 – 15	
16 – 17	
18 – 19	
20 – 21	
22 – 23	
24 – 25	
26 – 27	
28 – 29	
TOTAL	



General Certificate of Secondary Education
Foundation Tier
June 2014

Applications of Mathematics (Linked Pair Pilot)

93702F

F

Unit 2 Geometry and Measures

Friday 13 June 2014 9.00 am to 10.30 am

<p>For this paper you must have:</p> <ul style="list-style-type: none"> • a calculator • mathematical instruments. 	
---	--

Time allowed

- 1 hour 30 minutes

Instructions

- Use black ink or black ball-point pen. Draw diagrams in pencil.
- Fill in the boxes at the top of this page.
- Answer **all** questions.
- You must answer the questions in the spaces provided. Do not write outside the box around each page or on blank pages.
- Do all rough work in this book. Cross through any work that you do not want to be marked.
- If your calculator does not have a π button, take the value of π to be 3.14 unless another value is given in the question.

Information

- The marks for questions are shown in brackets.
- The maximum mark for this paper is 80
- The quality of your written communication is specifically assessed in Questions 9, 11 and 18
These questions are indicated with an asterisk (*)
- You may ask for more answer paper, graph paper and tracing paper. These must be tagged securely to this answer book.
- You are expected to use a calculator where appropriate.

Advice

- In all calculations, show clearly how you work out your answer.



Formulae Sheet: Foundation Tier

Area of trapezium = $\frac{1}{2}(a+b)h$

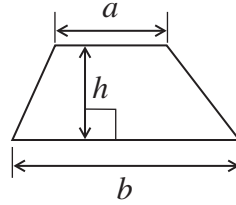

Volume of prism = area of cross section \times length

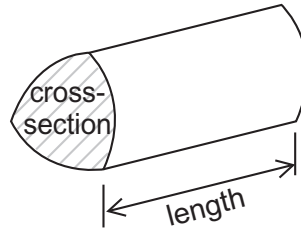

Answer **all** questions in the spaces provided.

1 (a) Amir weighs a parcel.

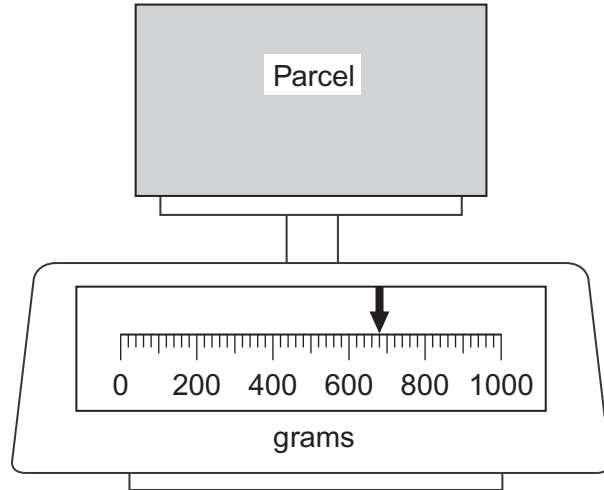

What is the weight of his parcel?

[1 mark]

Answer grams

1 (b) Beth has a parcel that weighs 1600 grams.

What is 1600 grams in kilograms?

[1 mark]

Answer kilograms



2 Debbie buys sweets and a magazine.

The sweets cost £1.89

The magazine costs £1.65

She pays with a £5 note.

She gets exactly five coins in her change.

What five coins does she get?

[3 marks]

.....

.....

.....

.....

.....

.....

.....

.....

Answer



3 Salim is making a design on a centimetre grid.

3 (a) The design is incomplete.
The dashed lines are lines of symmetry.

Complete the design.

[2 marks]

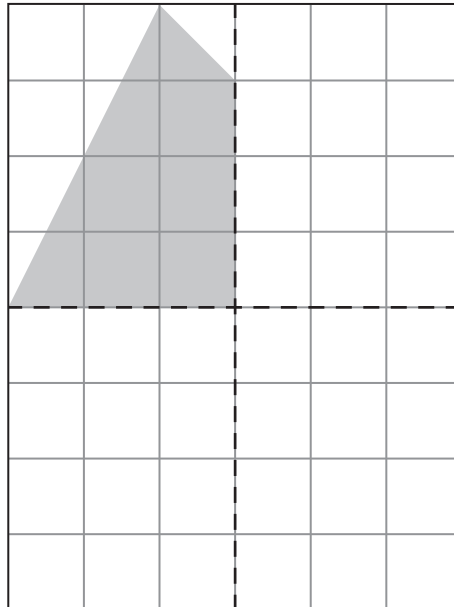

3 (b) Show that Salim can print 6 of these designs on a rectangular piece of paper that measures 25 cm by 15 cm.
You may use drawings to help explain your answer.

[2 marks]



4 The table shows the cost, **per night**, of single rooms and double rooms at a hotel.

	Friday to Sunday	Monday to Thursday
Single room	£70	£110
Double room	£120	£140

4 (a) Katie books a single room.
She starts her stay on Saturday night.
She stays for **four** nights.

Work out how much she pays altogether.

[3 marks]

.....

.....

.....

.....

£

4 (b) Mr and Mrs Smith book a double room for **two** nights.
They start their stay on Thursday night.
They both have breakfast at the hotel on Friday morning.
Breakfast at the hotel costs £11.50 **per person**.

Complete the following bill for their stay.

[3 marks]

	Room (£)	Breakfast (£)	Daily total (£)
Thursday		 	
Friday			
Total (£)			



- 5 A tray for holding paper clips is an **open** cuboid.

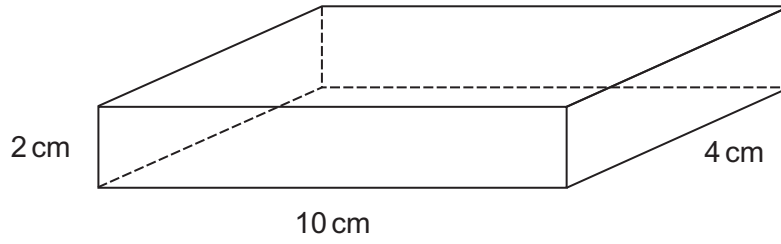

Complete a net for the tray on the grid.

[3 marks]

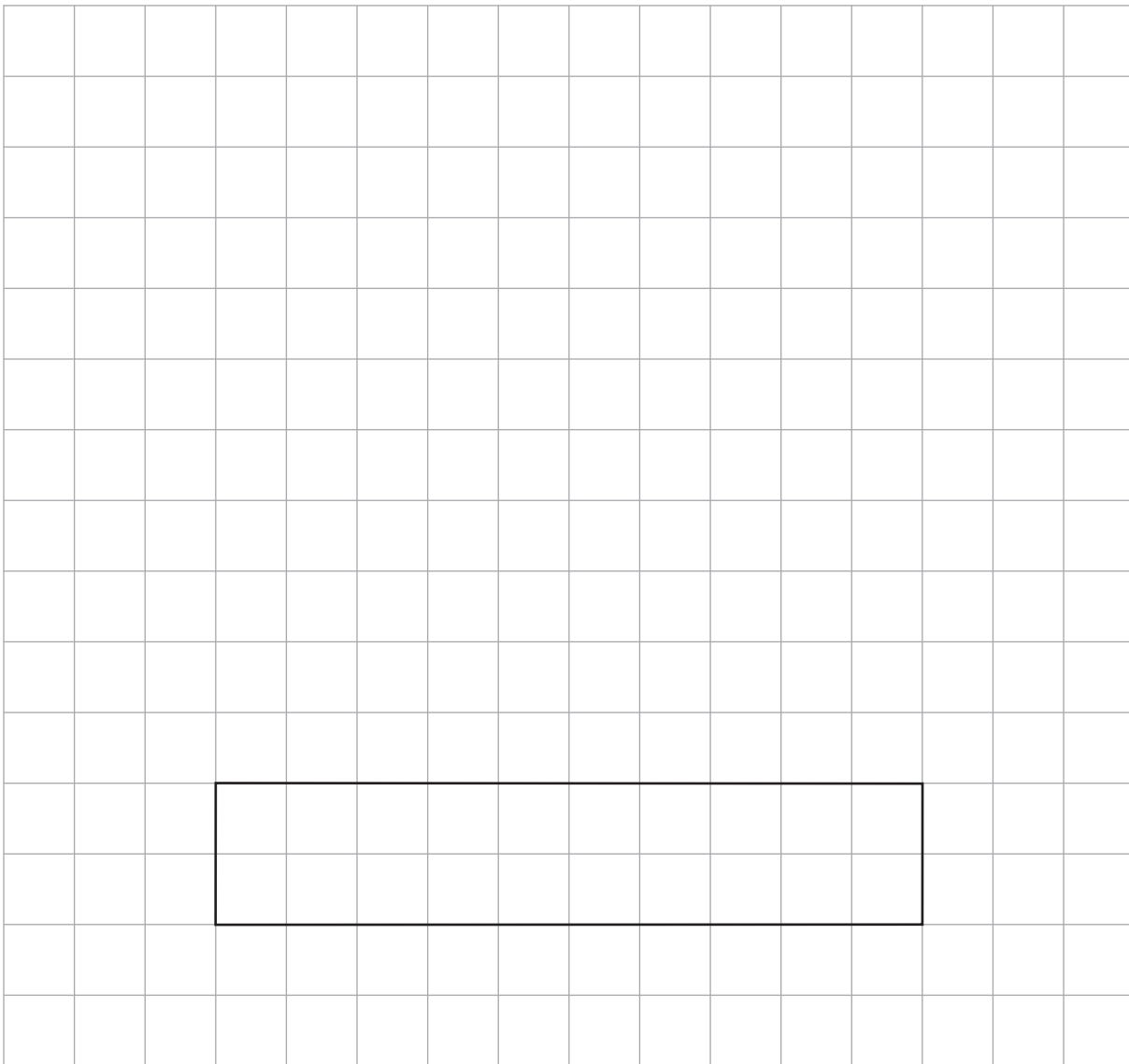

- 6** A company logo is a circle with two right-angled triangles drawn inside. The centre of the circle is marked with a dot.

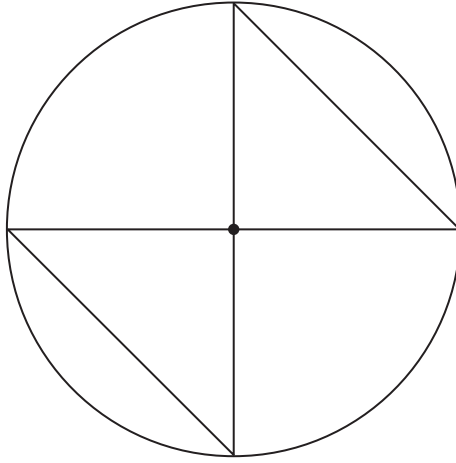

- 6 (a)** Write down the order of rotational symmetry of the logo.

[1 mark]

Answer

- 6 (b)** Measure the diameter of the circle. State the units of your answer.

[2 marks]

Answer



6 (c)

A different logo has

- **two** circles, radii 6 cm and 4 cm, with the same centre
- three straight lines drawn from the centre.

Here is a sketch of the logo.

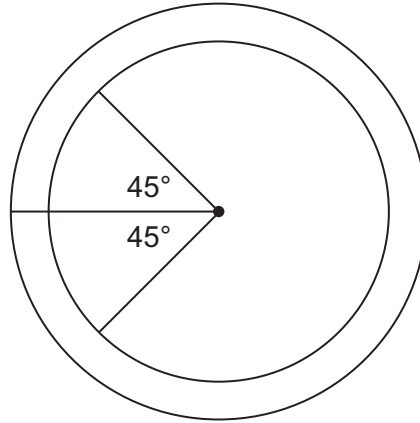
Not drawn
accurately

Complete this accurate drawing of the logo on the centimetre grid.

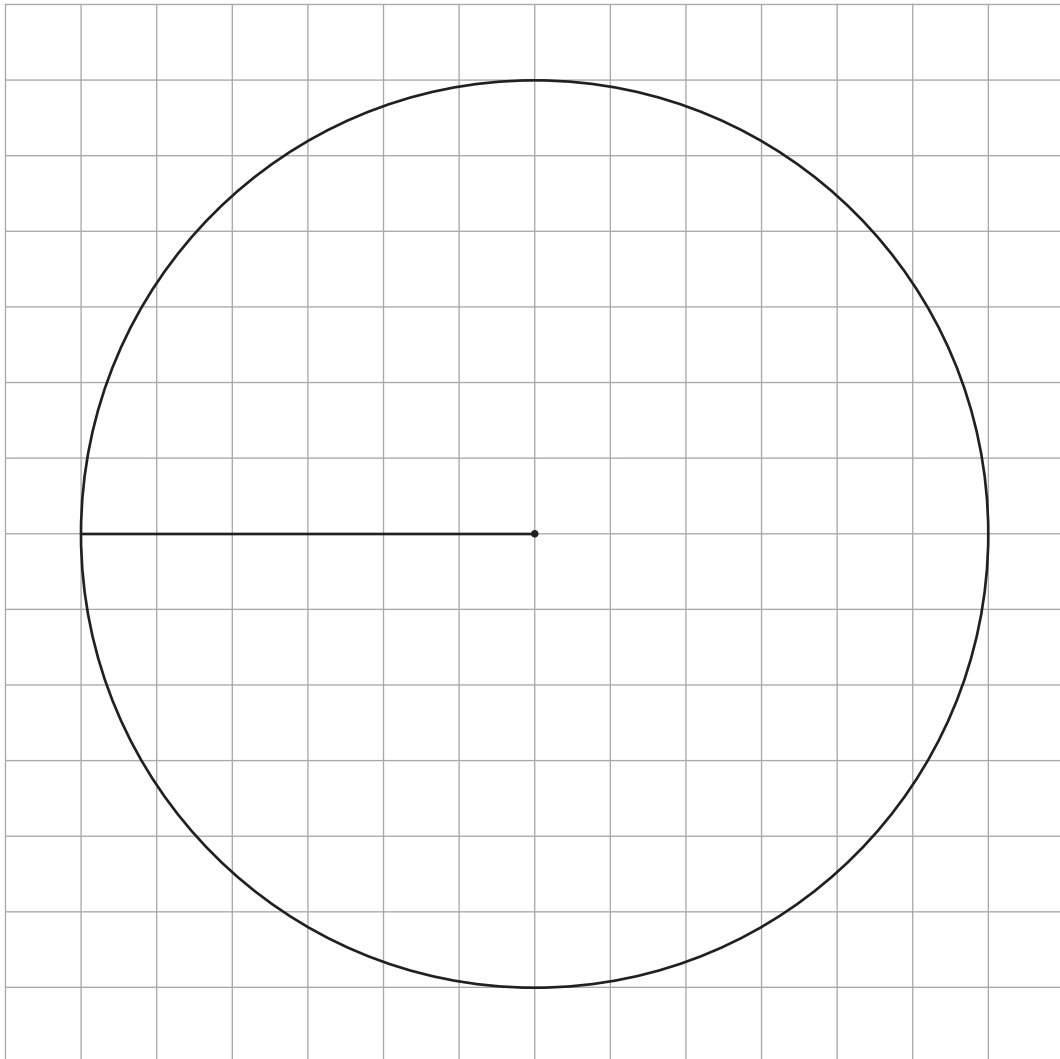
[2 marks]

5

Turn over ►



7 Square tables are put in rows.

One person can sit at each available edge of a table.
People can **not** sit at an edge where two tables join.

Examples

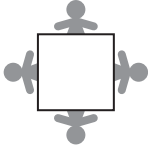

A single table
4 people

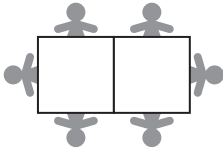

A row of 2 tables
6 people

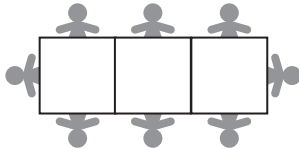

A row of 3 tables
8 people

7 (a) How many people can sit at a row of 7 tables?

[2 marks]

Answer



7 (b) 12 tables are put in a room.

There must be

only one row of 4 tables
no single tables.

Show how the 12 tables can be arranged so that **exactly** 30 people can sit at the tables.
[3 marks]

Practise on this diagram of the room.



Put your final answer on this diagram of the room.

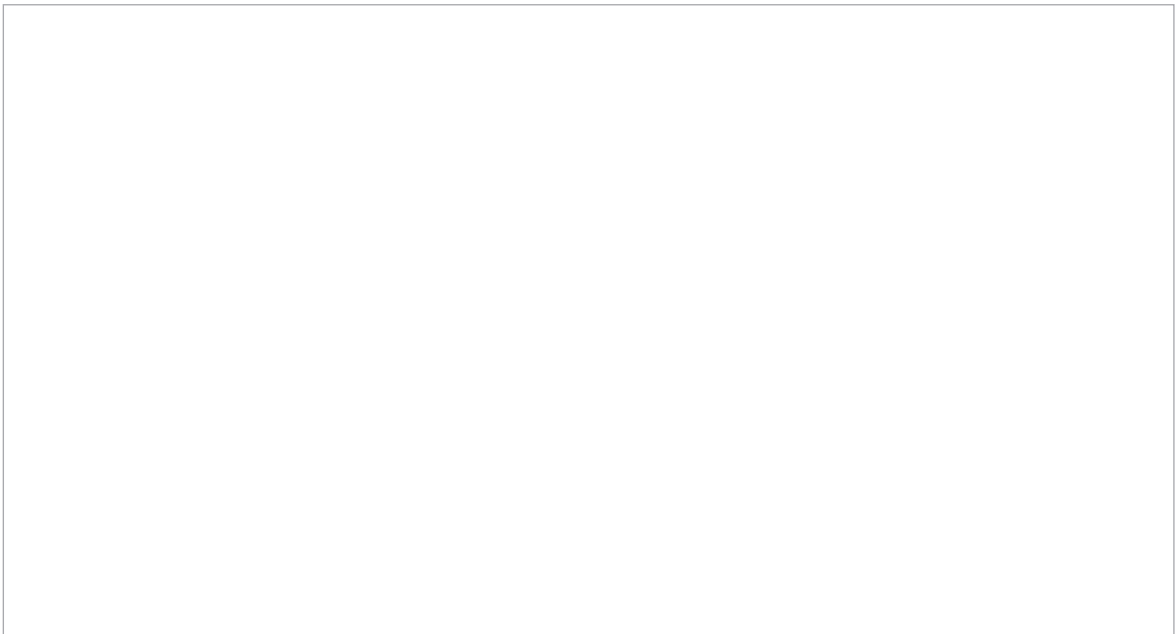

8 Here is a scale diagram of a village.
The grid lines are the roads in the village.

Scale 1 centimetre represents 100 metres

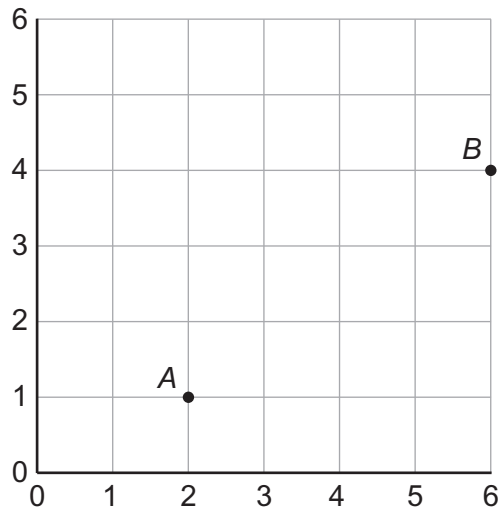

8 (a) Alan's house, *A*, has coordinates (2, 1).

Write down the coordinates of Ben's house, *B*.

[1 mark]

Answer (..... ,)

8 (b) Alan walks along the roads from *A* to *B*.

Work out the **shortest** possible distance that he can walk.

[2 marks]

.....

Answer metres

8 (c) Colin's house, *C*, is in the village.

The shortest distance along the roads from *C* to *A* is 600 metres.

The shortest distance along the roads from *C* to *B* is 500 metres.

Work out the coordinates of *C*.

[2 marks]

Answer (..... ,)



9 The diagram shows the position of ships *A* and *B*.

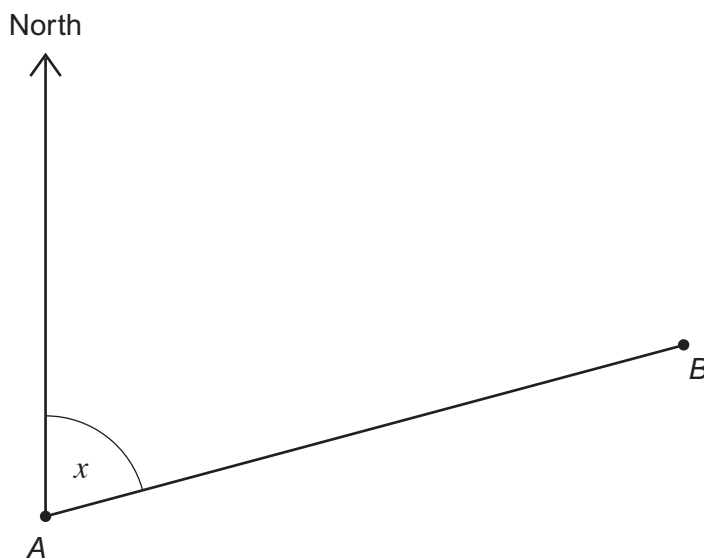

9 (a) Circle the size of angle *x* [1 mark]

- 55° 65° 75° 85° 95°

*9 (b) What is the 3-figure bearing of *B* from *A*? [1 mark]

Answer

Turn over for the next question



10 Jenna uses straight rods to make letters and numbers.

10 (a)

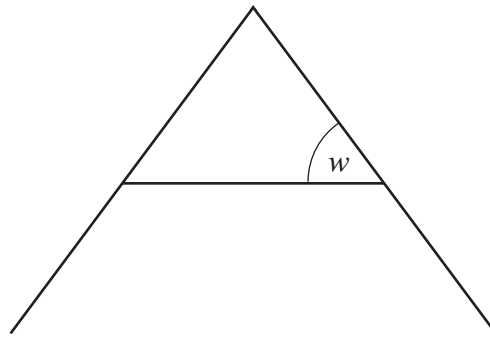

Not drawn
accurately

The triangle is equilateral.

What is the size of angle w ?

[1 mark]

Answer degrees

10 (b)

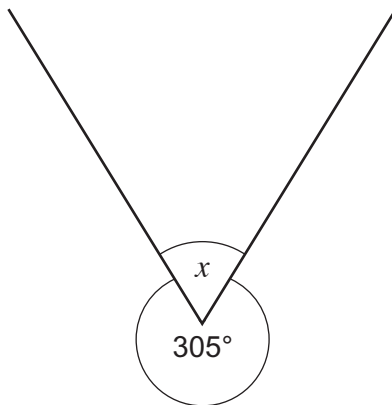

Not drawn
accurately

Work out the size of angle x .

[1 mark]

.....

Answer degrees



10 (c)

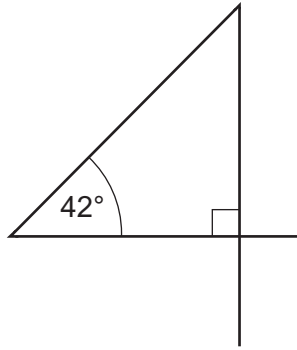

Not drawn
accurately

Is the triangle isosceles?
Give a reason for your answer.

[1 mark]

.....

.....

.....

Turn over for the next question



11 Small square tiles are all the same size.
They are either grey or white.

25 of the small tiles are used to make one large tile as shown.

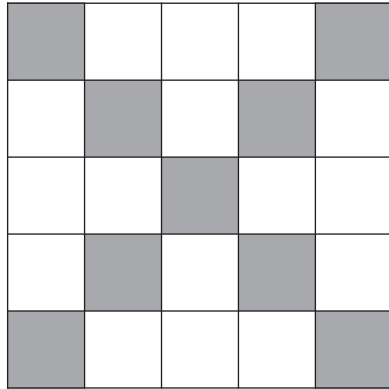

Not drawn
accurately

11 (a) How many small **white** tiles are needed to make one large tile?

[1 mark]

Answer

***11 (b)** The length of each small tile is 20 cm

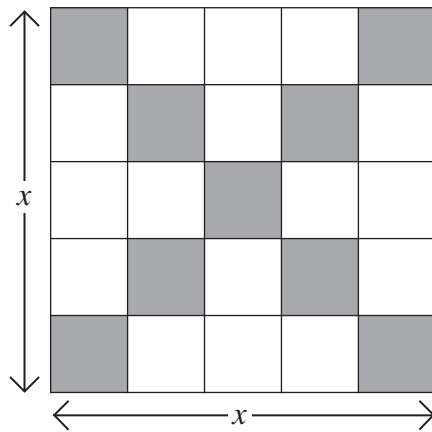

Not drawn
accurately

Show that x is 1 metre.

[2 marks]

.....

.....

.....



11 (c) Large tiles are used to cover a rectangular wall.
The wall measures 5 metres by 3 metres.

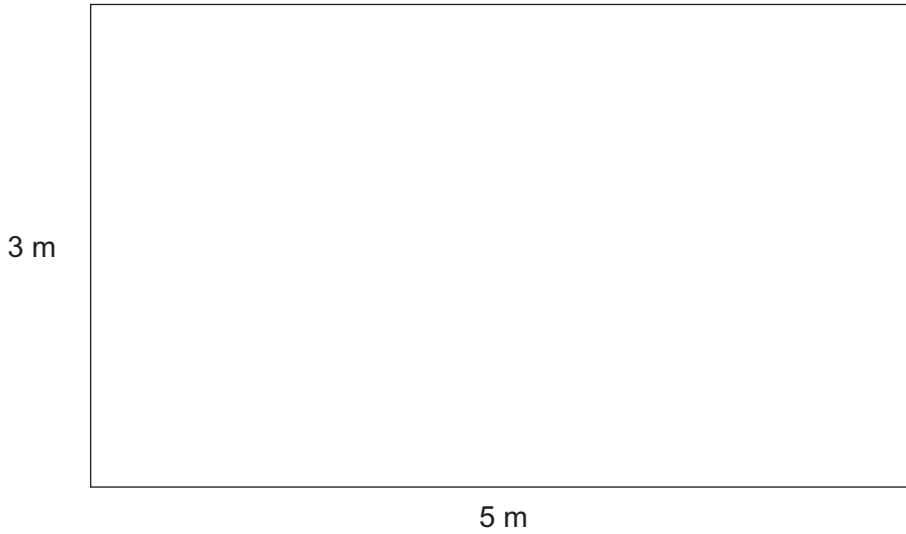

Not drawn
accurately

Work out how many small **white** tiles are needed.

[3 marks]

.....

.....

.....

.....

.....

.....

Answer



- 12 The graph shows the cost of taxi journeys of up to 6 miles.

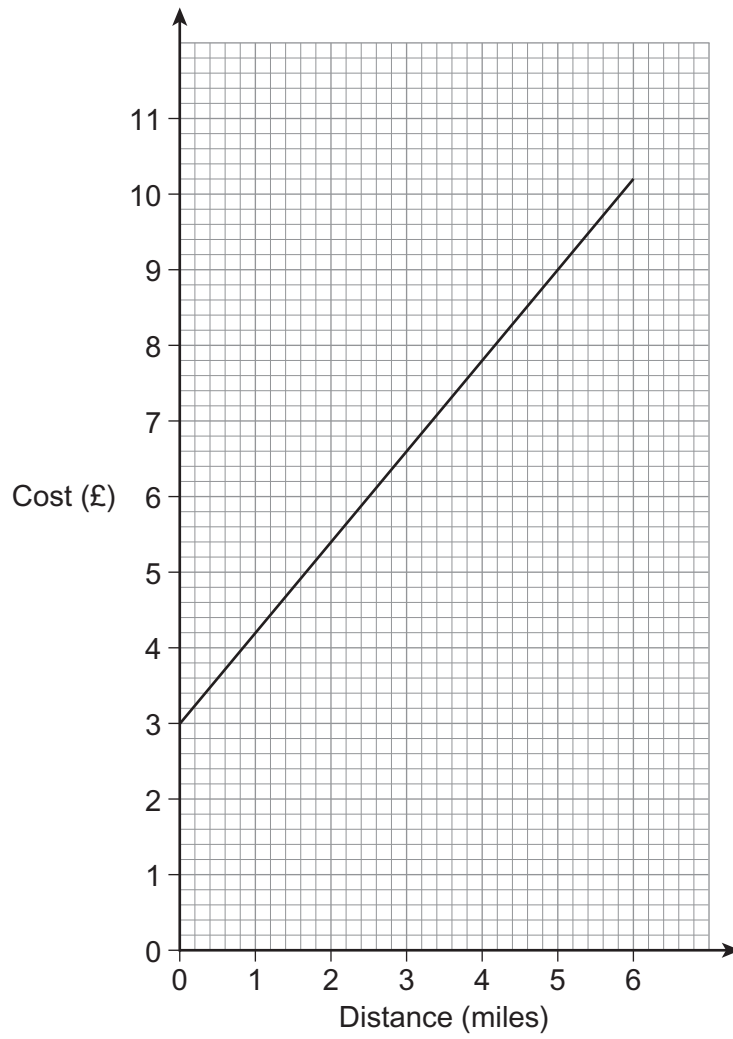

12 (a) A taxi journey costs £9
How many miles was the journey? **[1 mark]**

Answer miles

12 (b) How much does a taxi journey of 1 mile cost? **[1 mark]**

£

12 (c) How much **more** does a taxi journey cost for each extra mile? **[1 mark]**

£

Turn over for the next question

3

Turn over ►



13 (a) How much is 1 gallon in litres?
Circle the closest estimate.

[1 mark]

- 0.7 litres 2.2 litres 2.5 litres 4.5 litres 8.5 litres

13 (b) A fish tank is in the shape of a cuboid measuring 30 cm by 20 cm by 20 cm

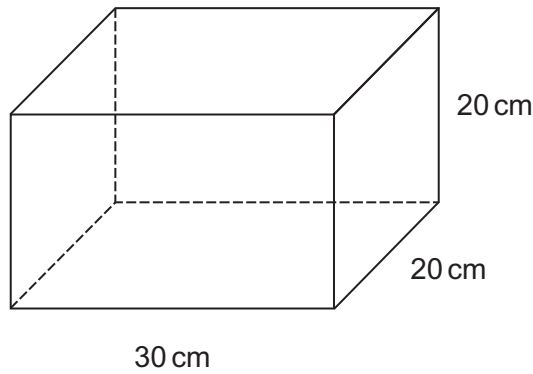

You are given that $1000 \text{ cm}^3 = 1 \text{ litre}$

Can the fish tank hold more than 2 gallons of water?
You **must** show your working.

[3 marks]

.....

.....

.....

.....

.....



14 Here is a rectangular school playing field.

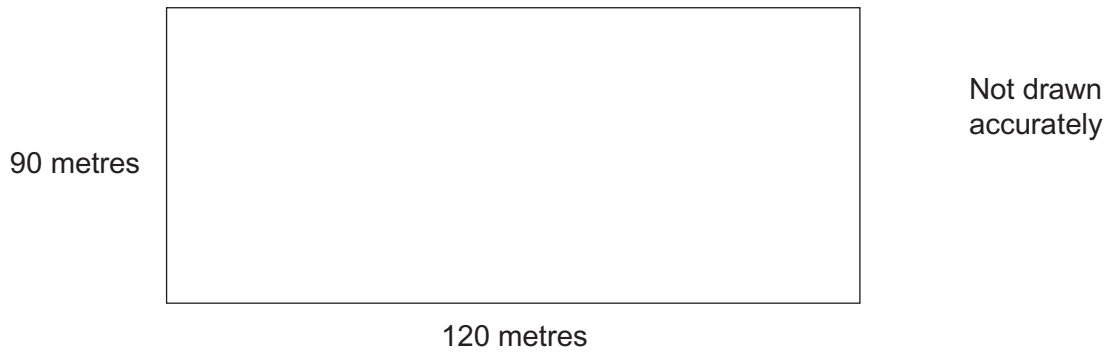

14 (a) The field is to have a new fence around the perimeter.

Work out the perimeter of the field.

[2 marks]

.....

.....

.....

Answer m

14 (b) The field is covered with turf.
The cost of the turf is £4.15 per square metre.

Work out the total cost.
Give your answer to the nearest £1000

[4 marks]

.....

.....

.....

.....

.....

.....

£

10

Turn over ►



15 A conversion graph for speeds is shown.

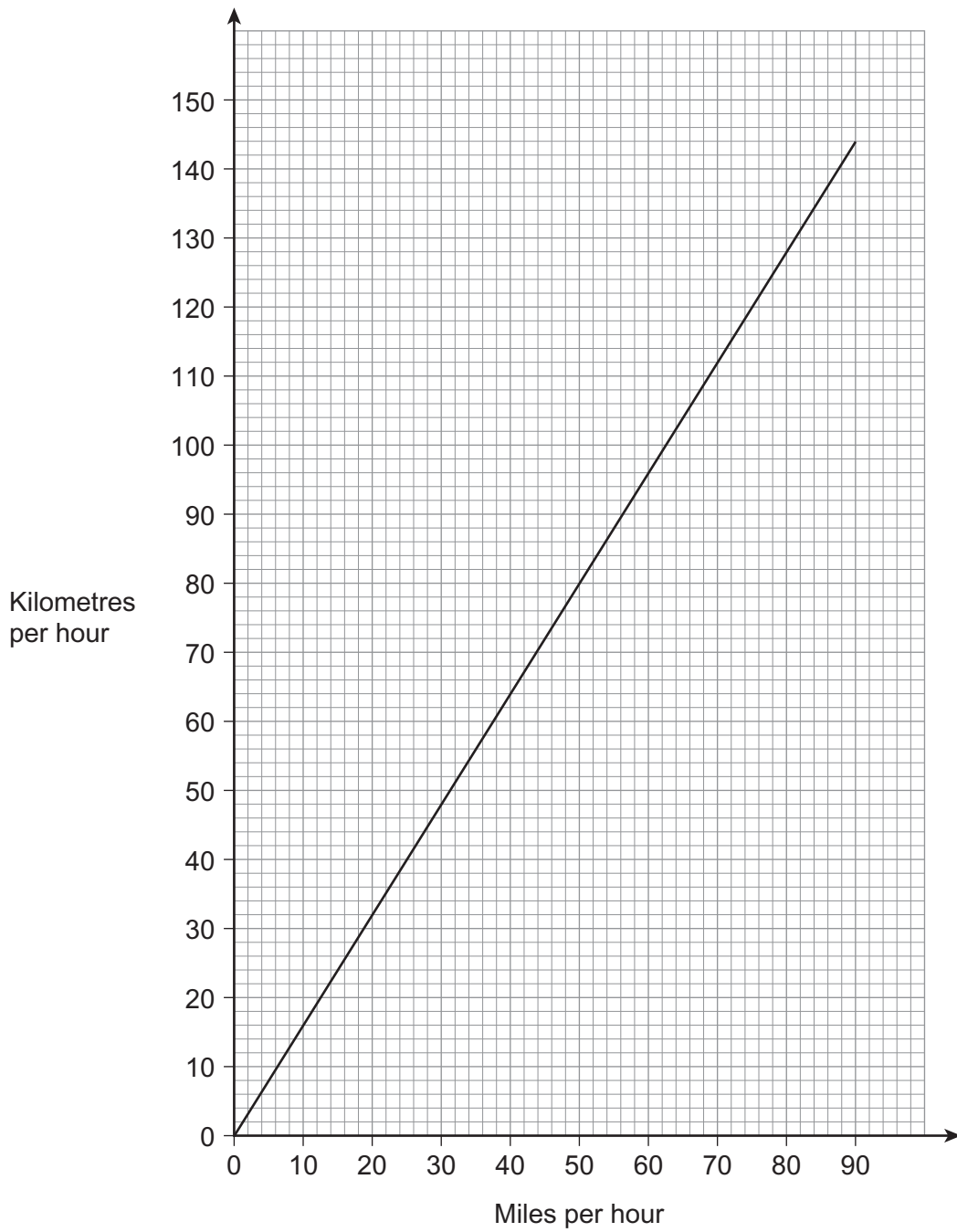

15 (a) In France the motorway speed limit is 130 kilometres per hour.
In the UK the motorway speed limit is 70 miles per hour.

In which country is the motorway speed limit higher?
You **must** show your working, which may be on the graph.

[1 mark]

.....
.....

Answer

15 (b) Tom is on holiday in France.

He leaves Calais at 10.45 am
The distance from Calais to Paris is 288 kilometres.

He says,

“If I drive at an average speed of 60 **miles per hour** I will be in Paris before 2 pm”

Is he correct?
You **must** show your working.

[4 marks]

.....
.....
.....
.....
.....
.....
.....
.....
.....

5

Turn over ►



- 16 Here is a metal badge in the shape of a kite.

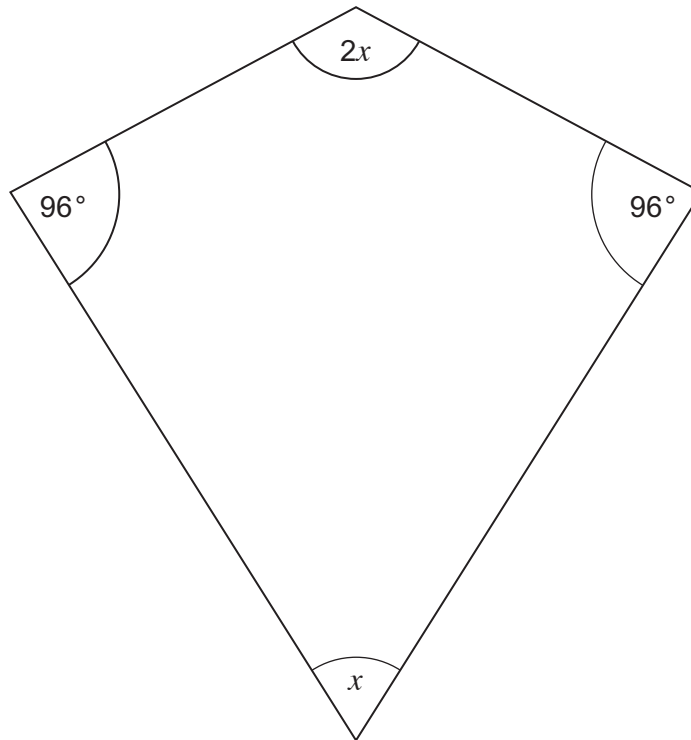

Not drawn
accurately

- 16 (a) Set up and solve an equation to work out the value of x .

[3 marks]

.....

.....

.....

.....

.....

.....

$x =$



16 (b) The badge is cut from a rectangular sheet of metal as shown.

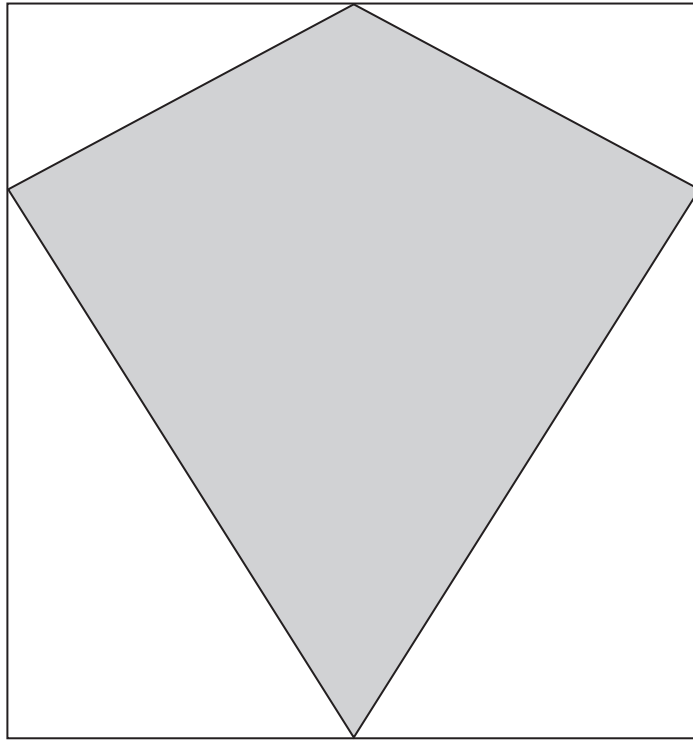

Not drawn
accurately

Cathy says,

“The area of the badge is **exactly** half the area of the rectangle.”

Give reasons why she is correct.
You may use the diagram to help you.

[2 marks]

.....

.....

.....

.....

.....

5

Turn over ►



17

Pancakes for 6 people
50 g flour
25 g butter
1 egg
150 ml milk

How much milk is needed to make pancakes for 15 people?

[3 marks]

.....
.....
.....
.....

Answer ml



***18** You need a ruler and compasses to answer this question.

A map of an island is shown on the grid.

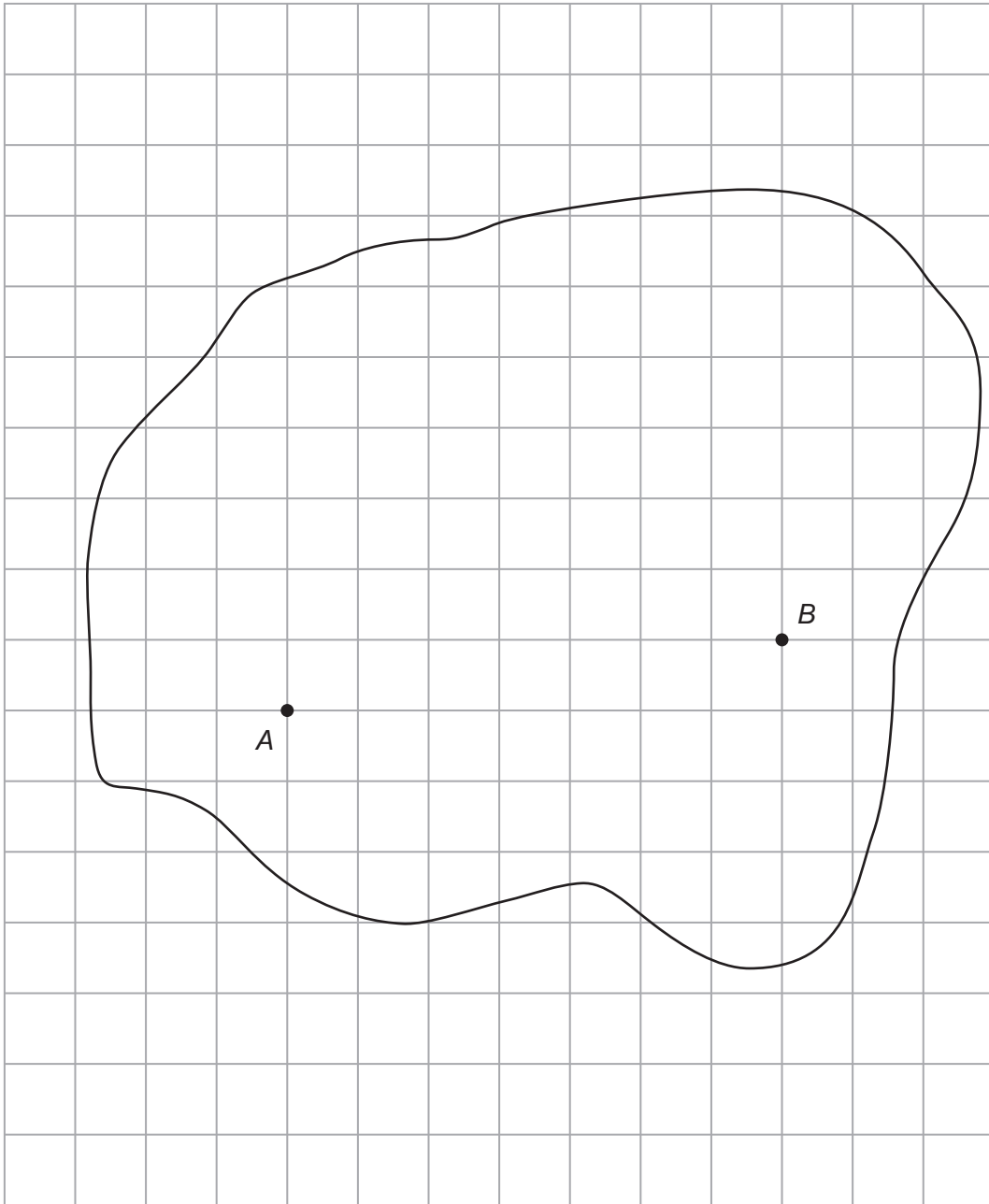

Treasure is buried on the island.

The treasure is the same distance from *A* as it is from *B*.

Construct a line on the map to show **all** the places where the treasure could be.

[3 marks]



- 19** Mr Brown makes a rectangular chicken run, $PQRS$.
 One side is an existing wall.
 The other three sides are made from 70 metres of fencing.

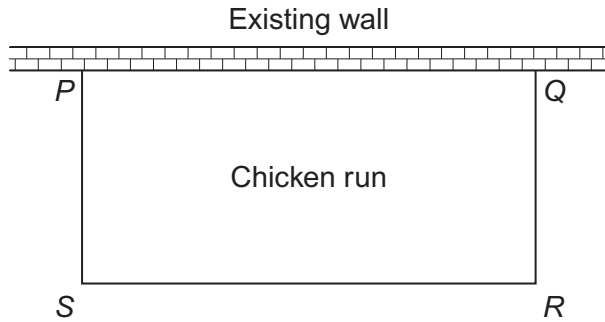

Not drawn accurately

- 19 (a)** When $PS = 22$ metres, work out the area of the chicken run.

[2 marks]

.....

Answer m^2

- 19 (b)** When $PS = x$ metres, the area of the chicken run, A square metres, is given by $A = 70x - 2x^2$

Here is a table of values for $A = 70x - 2x^2$

x	0	5	10	15	17.5	20	25	30	35
A	0	300	500	600	612.5	600	500	300	0

Draw the graph of $A = 70x - 2x^2$ for values of x from 0 to 35

[2 marks]



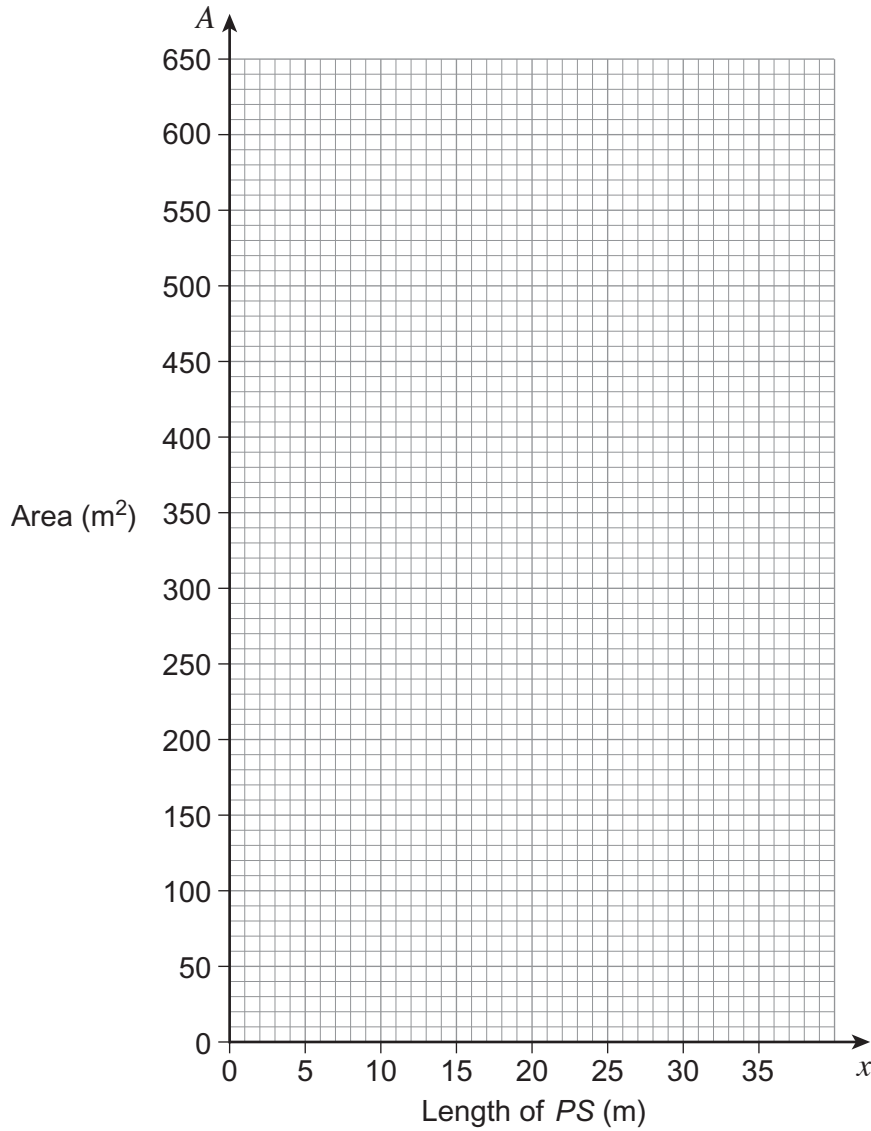

19 (c) Mr Brown makes the chicken run so that it has the **largest possible** area. On average, each chicken needs an area of 0.75 m^2 to live safely.

Work out the largest number of chickens that can live safely in the chicken run. You **must** show your working.

[3 marks]

.....

.....

.....

.....

Answer

END OF QUESTIONS

7



There are no questions printed on this page

**DO NOT WRITE ON THIS PAGE
ANSWER IN THE SPACES PROVIDED**



There are no questions printed on this page

**DO NOT WRITE ON THIS PAGE
ANSWER IN THE SPACES PROVIDED**



There are no questions printed on this page

**DO NOT WRITE ON THIS PAGE
ANSWER IN THE SPACES PROVIDED**

