

Centre Number						Candidate Number				
Surname										
Other Names										
Candidate Signature										

For Examiner's Use	
Examiner's Initials	
Pages	Mark
3	
4 – 5	
6 – 7	
8 – 9	
10 – 11	
12 – 13	
14 – 15	
16 – 17	
18 – 19	
20 – 21	
22 – 23	
TOTAL	



General Certificate of Secondary Education
Higher Tier
June 2014

Mathematics (Linear)

4365/1H

Paper 1

Monday 9 June 2014 9.00 am to 10.30 am

H

<p>For this paper you must have:</p> <ul style="list-style-type: none"> mathematical instruments. <p>You must not use a calculator</p>	
---	--

Time allowed

- 1 hour 30 minutes

Instructions

- Use black ink or black ball-point pen. Draw diagrams in pencil.
- Fill in the boxes at the top of this page.
- Answer **all** questions.
- You must answer the questions in the spaces provided. Do not write outside the box around each page or on blank pages.
- Do all rough work in this book.

Information

- The marks for questions are shown in brackets.
- The maximum mark for this paper is 70.
- The quality of your written communication is specifically assessed in Questions 2, 15 and 16. These questions are indicated with an asterisk (*).
- You may ask for more answer paper, tracing paper and graph paper. These must be tagged securely to this answer book.

Advice

- In all calculations, show clearly how you work out your answer.



J U N 1 4 4 3 6 5 1 H 0 1

Formulae Sheet: Higher Tier

Area of trapezium = $\frac{1}{2}(a+b)h$

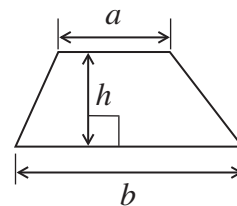

Volume of prism = area of cross section \times length

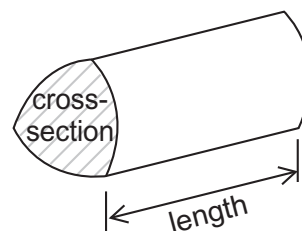

Volume of sphere = $\frac{4}{3}\pi r^3$

Surface area of sphere = $4\pi r^2$



Volume of cone = $\frac{1}{3}\pi r^2 h$

Curved surface area of cone = $\pi r l$



In any triangle ABC

Area of triangle = $\frac{1}{2}ab \sin C$

Sine rule $\frac{a}{\sin A} = \frac{b}{\sin B} = \frac{c}{\sin C}$

Cosine rule $a^2 = b^2 + c^2 - 2bc \cos A$

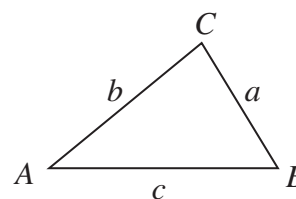

The Quadratic Equation

The solutions of $ax^2 + bx + c = 0$, where $a \neq 0$, are given by

$$x = \frac{-b \pm \sqrt{b^2 - 4ac}}{2a}$$



Answer **all** questions in the spaces provided.

1 Circle the correct word to describe the following.

1 (a) $2x - 7y$

[1 mark]

Equation

Expression

Formula

Identity

1 (b) $P = 2l + 2w$

[1 mark]

Equation

Expression

Formula

Identity

1 (c) $8(x - y) \equiv 8x - 8y$

[1 mark]

Equation

Expression

Formula

Identity

Turn over for the next question



*2 A shop is having a sale on DVDs and CDs.

DVDs are sold at one price.
CDs are sold at a different price.

2 DVDs and 1 CD cost £35
2 DVDs and 2 CDs cost £45

Martin has £50

Does he have enough to buy 1 DVD and 3 CDs?
You **must** show your working.

[5 marks]

.....

.....

.....

.....

.....

.....

.....

.....



3 (a) Write down four **different** numbers that have
a **median** of 5
and a **range** of 7.

Put the numbers in order.

[2 marks]

.....
.....

Answer,,,

3 (b) The table shows the scores of 20 students in a test.

Score	Frequency
7	6
8	9
9	4
10	1
Total	20

Work out the mean score.

[3 marks]

.....
.....

Answer

10

Turn over ►



4 (a) Work out the area of this parallelogram.

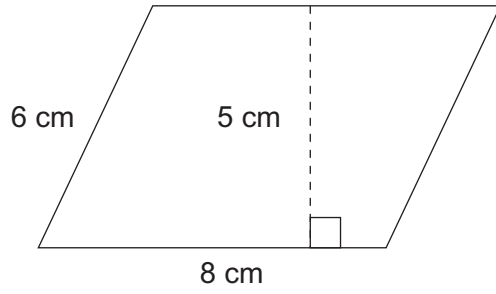

Not drawn
accurately

State the units of your answer.

[3 marks]

.....

.....

.....

Answer



4 (b) Shaz is drawing quadrilaterals on a nine-point square grid by joining points.

For example

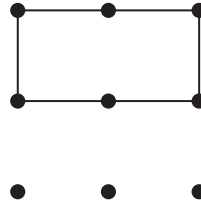
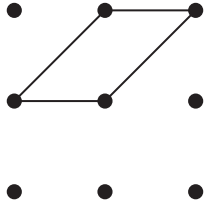

She says,

“If you draw a quadrilateral it will **always** have line or rotational symmetry.”

Draw a quadrilateral on the grid below to show that Shaz is wrong.
Use the first two grids for practice and the bottom grid for your answer.

[1 mark]

Practice grids

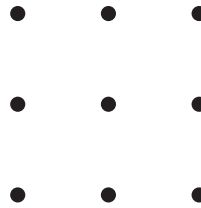
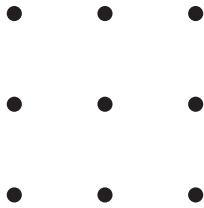

Answer grid

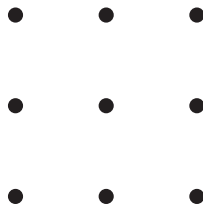

5 (a) Work out the Highest Common Factor (HCF) of 24 and 42

[2 marks]

.....
.....

Answer

5 (b) As a product of prime factors $36 = 2^2 \times 3^2$

Write 48 as a product of prime factors.

[2 marks]

.....
.....

Answer



6 Here are four scatter diagrams.

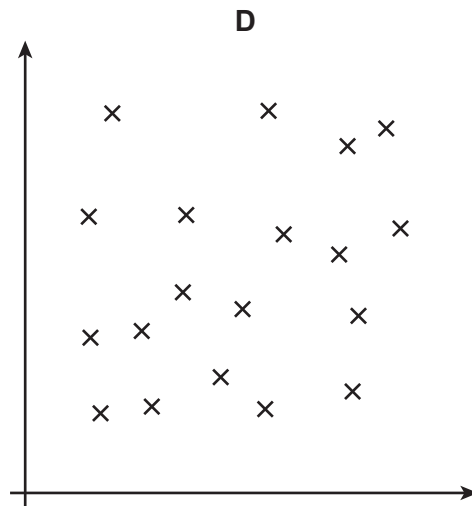
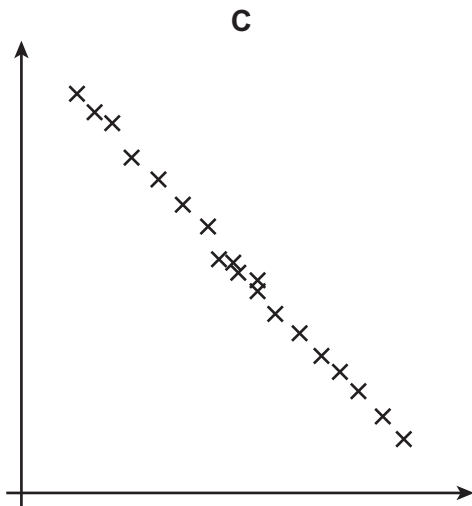
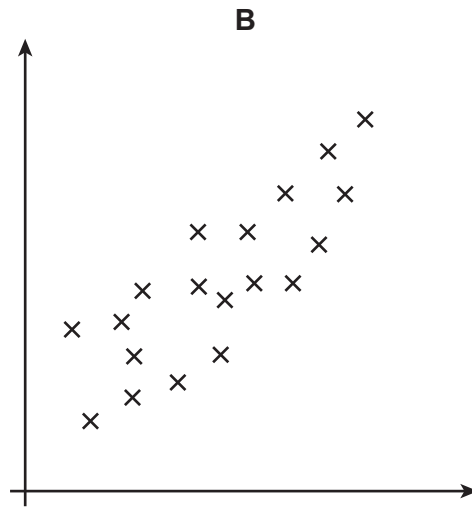
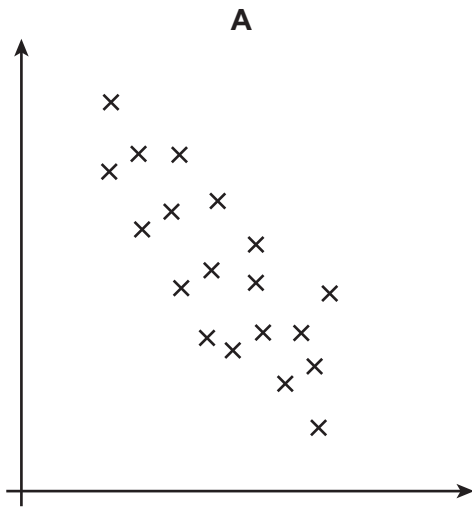

Choose a letter to complete these sentences.

[2 marks]

Scatter diagram shows no correlation.

Scatter diagram shows positive correlation.

Scatter diagram shows strong negative correlation.

6

Turn over ►



7 This semi-circle has a radius of 5 cm

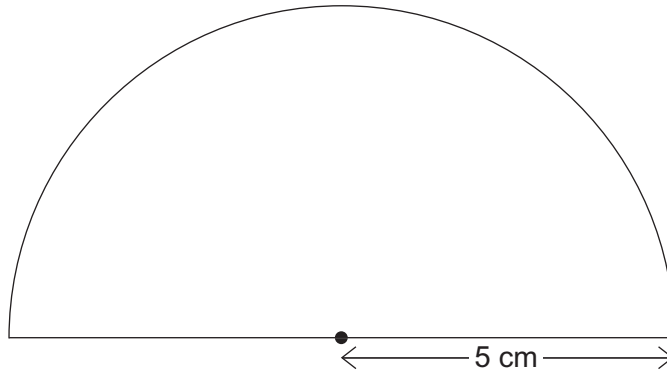

Not drawn
accurately

Work out the **perimeter** of the semi-circle.
Remember to include the base.
Use the approximation $\pi = 3.1$

[3 marks]

.....

.....

.....

.....

Answer..... cm



8 (a) Solve $x^2 = 36$

[2 marks]

.....
.....

Answer

8 (b) Solve $\frac{y + 1}{3} + \frac{y - 2}{2} = 2$

[4 marks]

.....
.....
.....
.....
.....
.....
.....
.....
.....
.....
.....
.....

y =



9 (a) The graph shows the line $y = ax + b$

Work out the values of a and b .

[2 marks]

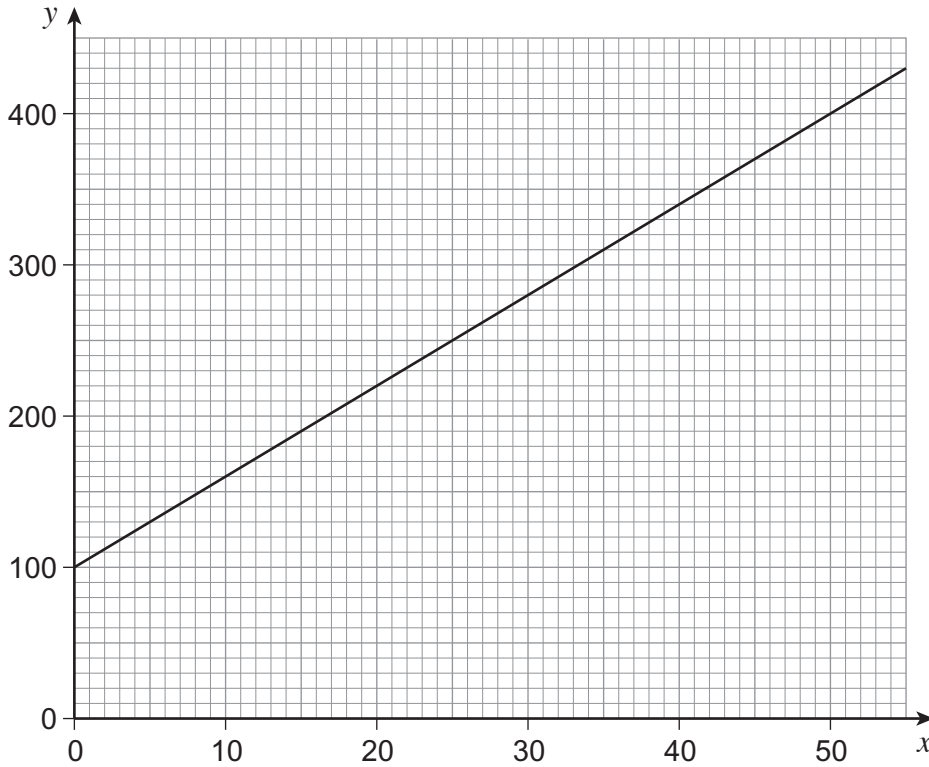

.....

.....

.....

.....

Answer $a =$

$b =$



9 (b) Work out the value of y when $x = 80$

[2 marks]

.....

.....

.....

.....

Answer

Turn over for the next question

4

Turn over ►



10 The table shows data about the times for men and women in a race.

	Mean	Interquartile range
Men	34m 50s	6m 30s
Women	40m 10s	4m 45s

Use data from the table to make **two** comparisons between the performances of the men and women in the race.

[2 marks]

Comparison 1

.....

.....

.....

.....

Comparison 2

.....

.....

.....

.....



11 Paul travels from Rye to Eston at an average speed of 90 km/h
He travels for T hours.

Mary makes the same journey at an average speed of 70 km/h
She travels for 1 hour longer than Paul.

Work out the value of T

[4 marks]

.....

.....

.....

.....

.....

.....

Answer hours

Turn over for the next question

6

Turn over ►



12 A and B are independent events.

Fill in **all** eight missing probabilities in the diagram below.

[4 marks]

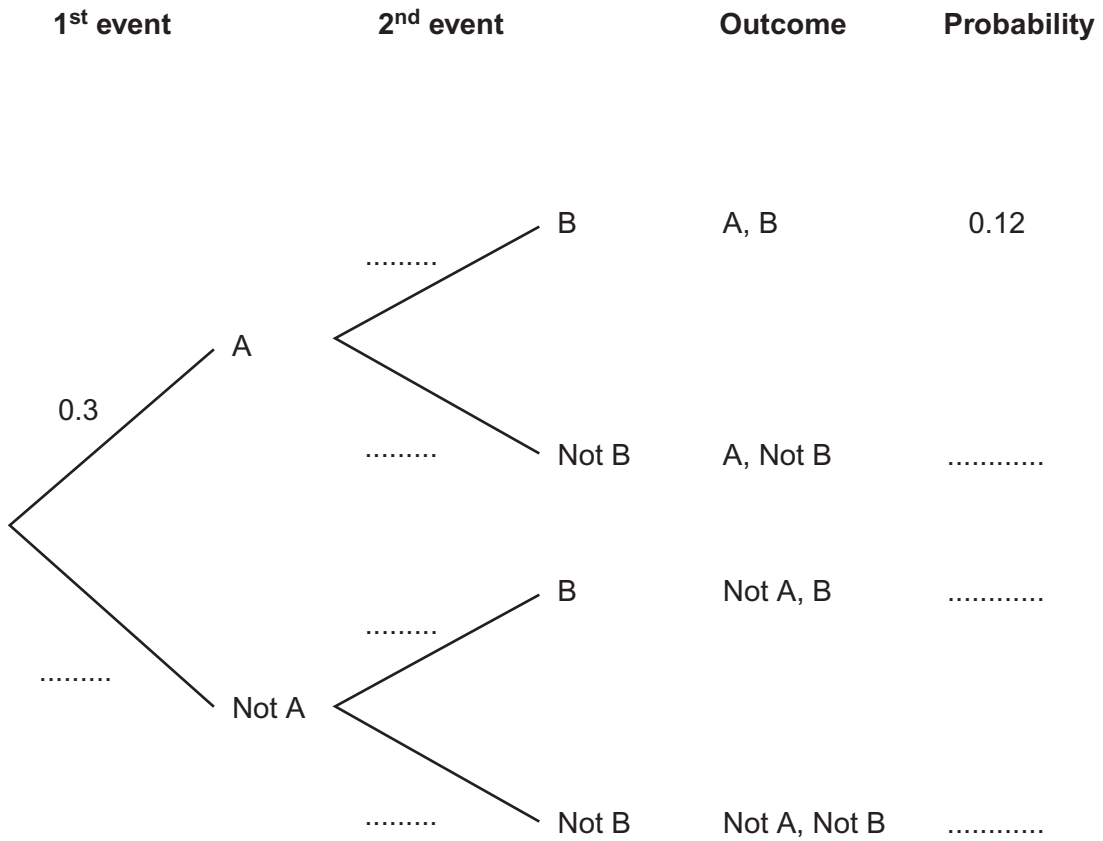

.....

.....

.....

.....



13 The sum of two numbers is 15.
The difference of the same two numbers is 8.

Use algebra to work out the numbers.

Do **not** use trial and improvement.
You **must** show your working.

[4 marks]

.....

.....

.....

.....

.....

.....

Answer and

Turn over for the next question

8

Turn over ►



14 The diagram shows two rectangles.

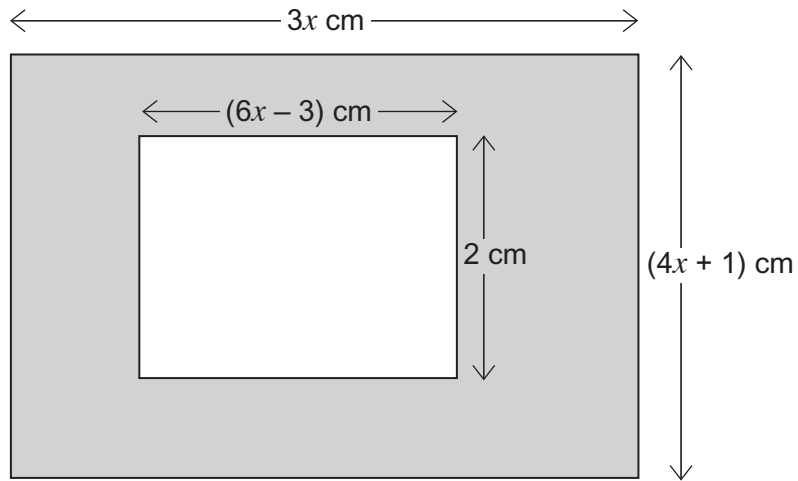

Not drawn
accurately

14 (a) Show the shaded area, in cm^2 , is given by $12x^2 - 9x + 6$

[2 marks]

.....

.....

.....

.....

.....

14 (b) The shaded area is 6 cm^2

Calculate the value of x .

[3 marks]

.....

.....

Answer



***15** $ABCD$ and $AEFG$ are identical squares.
 $CD = EF = 10$ cm
 Angle $BAG = 45^\circ$

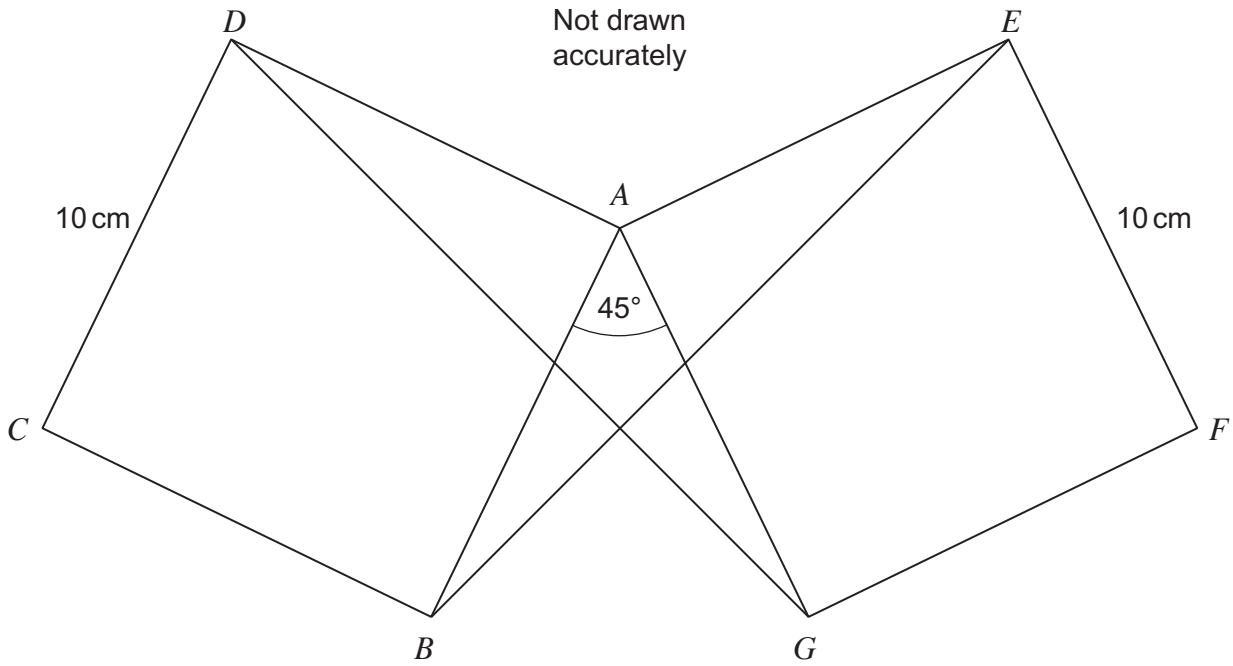

Prove that triangles AGD and ABE are congruent.

[4 marks]

.....

.....

.....

.....

.....

.....

.....

.....

.....

.....



16 (a) Show clearly that $(x - y)(x + y) \equiv x^2 - y^2$

[1 mark]

.....

.....

***16 (b)**

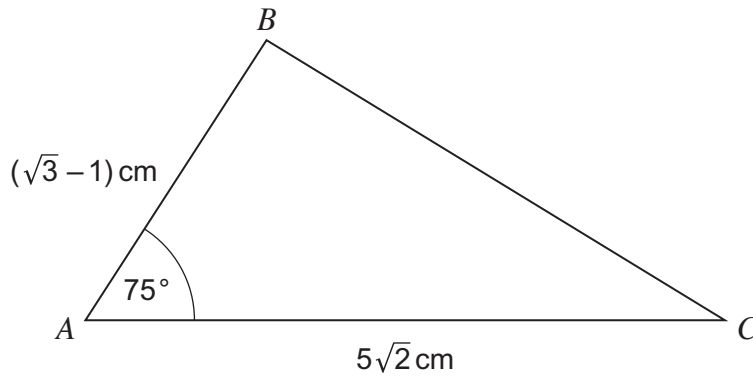

Not drawn
accurately

You are given that $\sin 75^\circ = \frac{\sqrt{3} + 1}{2\sqrt{2}}$

Show that the area of triangle ABC is $2\frac{1}{2} \text{ cm}^2$

[3 marks]

.....

.....

.....

.....

.....

.....

.....

.....

.....

.....



17 A pyramid has

a square base of side 10 cm
a height of 30 cm

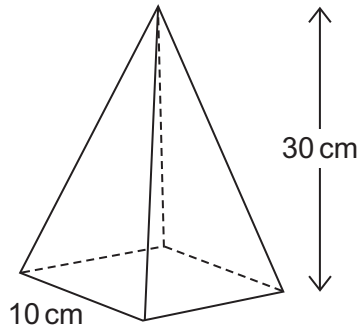

It is cut horizontally at a height of 15 cm
The top pyramid is removed to leave this frustum.

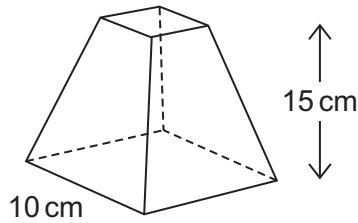

You are given the formula

$$\text{Volume of pyramid} = \frac{1}{3} \times \text{area of base} \times \text{vertical height}$$

Calculate the volume of the frustum.

[3 marks]

.....

.....

.....

.....

.....

.....

.....

.....

.....

Answer cm³

7

Turn over ►



- 18 The diagram shows a ball being thrown. It is thrown from a height h metres above level ground. It lands 7.5 metres from where it was thrown.

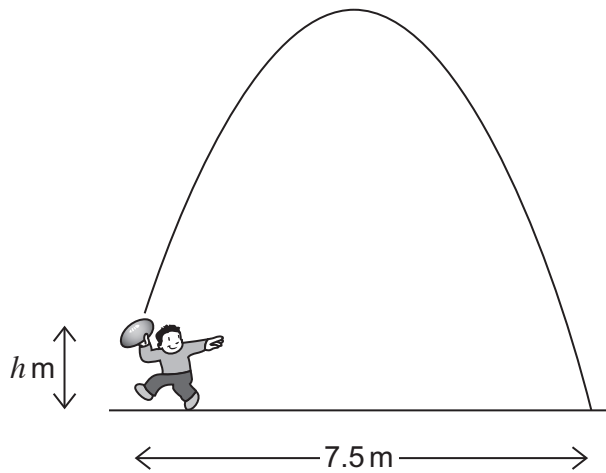

Not drawn
accurately

The path of the ball can be modelled by the equation $y = -\frac{1}{15}(2x + 1)(2x - 15)$

The sketch shows the graph of the equation.

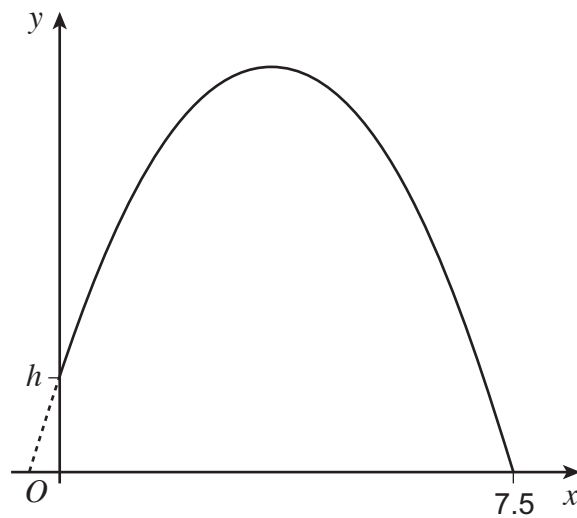

18 (a) Work out the value of h .
You **must** show your working.

[2 marks]

.....

.....

.....

Answer

18 (b) Show that the maximum height reached by the ball is $4\frac{4}{15}$ metres.

Use the symmetry of the graph to help you.

You **must** show your working.

[2 marks]

.....

.....

.....

.....

.....

.....

.....

.....

.....

.....

.....

.....

END OF QUESTIONS

4



There are no questions printed on this page

**DO NOT WRITE ON THIS PAGE
ANSWER IN THE SPACES PROVIDED**

