

Centre Number						Candidate Number				
Surname										
Other Names										
Candidate Signature										

For Examiner's Use	
Examiner's Initials	
Pages	Mark
3	
4 – 5	
6 – 7	
8 – 9	
10 – 11	
12 – 13	
14 – 15	
16 – 17	
18 – 19	
20 – 21	
22 – 23	
24 – 25	
26 – 27	
TOTAL	



General Certificate of Secondary Education
Higher Tier
June 2015

Mathematics

43603H

Unit 3

Monday 8 June 2015 9.00 am to 10.30 am

H

<p>For this paper you must have:</p> <ul style="list-style-type: none"> • a calculator • mathematical instruments. 	
---	--

Time allowed

- 1 hour 30 minutes

Instructions

- Use black ink or black ball-point pen. Draw diagrams in pencil.
- Fill in the boxes at the top of this page.
- Answer **all** questions.
- You must answer the questions in the spaces provided. Do not write outside the box around each page or on blank pages.
- Do all rough work in this book.
- If your calculator does not have a π button, take the value of π to be 3.14 unless another value is given in the question.

Information

- The marks for questions are shown in brackets.
- The maximum mark for this paper is 80.
- The quality of written communication is specifically assessed in Questions 3, 4, 5 and 17. These questions are indicated with an asterisk (*).
- You may ask for more answer paper, graph paper and tracing paper. These must be tagged securely to this answer booklet.

Advice

- In all calculations, show clearly how you work out your answer.



Formulae Sheet: Higher Tier

Area of trapezium = $\frac{1}{2}(a+b)h$

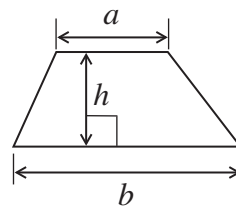

Volume of prism = area of cross-section \times length

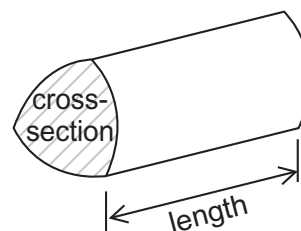

Volume of sphere = $\frac{4}{3}\pi r^3$

Surface area of sphere = $4\pi r^2$

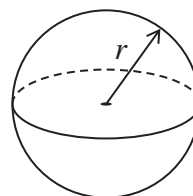

Volume of cone = $\frac{1}{3}\pi r^2 h$

Curved surface area of cone = $\pi r l$

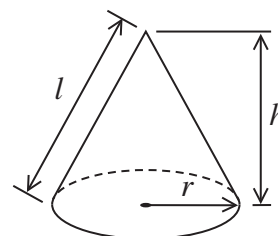

In any triangle ABC

Area of triangle = $\frac{1}{2}ab \sin C$

Sine rule $\frac{a}{\sin A} = \frac{b}{\sin B} = \frac{c}{\sin C}$

Cosine rule $a^2 = b^2 + c^2 - 2bc \cos A$

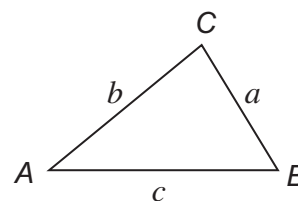

The Quadratic Equation

The solutions of $ax^2 + bx + c = 0$, where $a \neq 0$, are given by

$$x = \frac{-b \pm \sqrt{b^2 - 4ac}}{2a}$$



Answer **all** questions in the spaces provided.

1 Some water is shown in a 500 ml measuring jug.

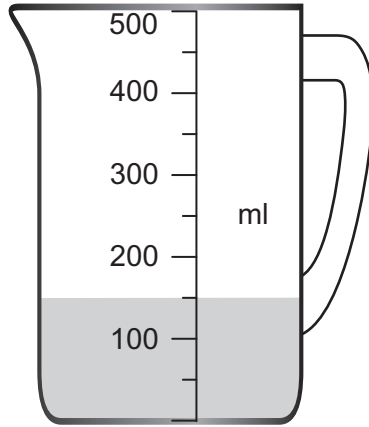

What percentage of the jug is filled with water?

[2 marks]

.....
.....
.....

Answer %

Turn over for the next question

Turn over ►



2 (a) Translate triangle T by the vector $\begin{pmatrix} 4 \\ -5 \end{pmatrix}$

[2 marks]

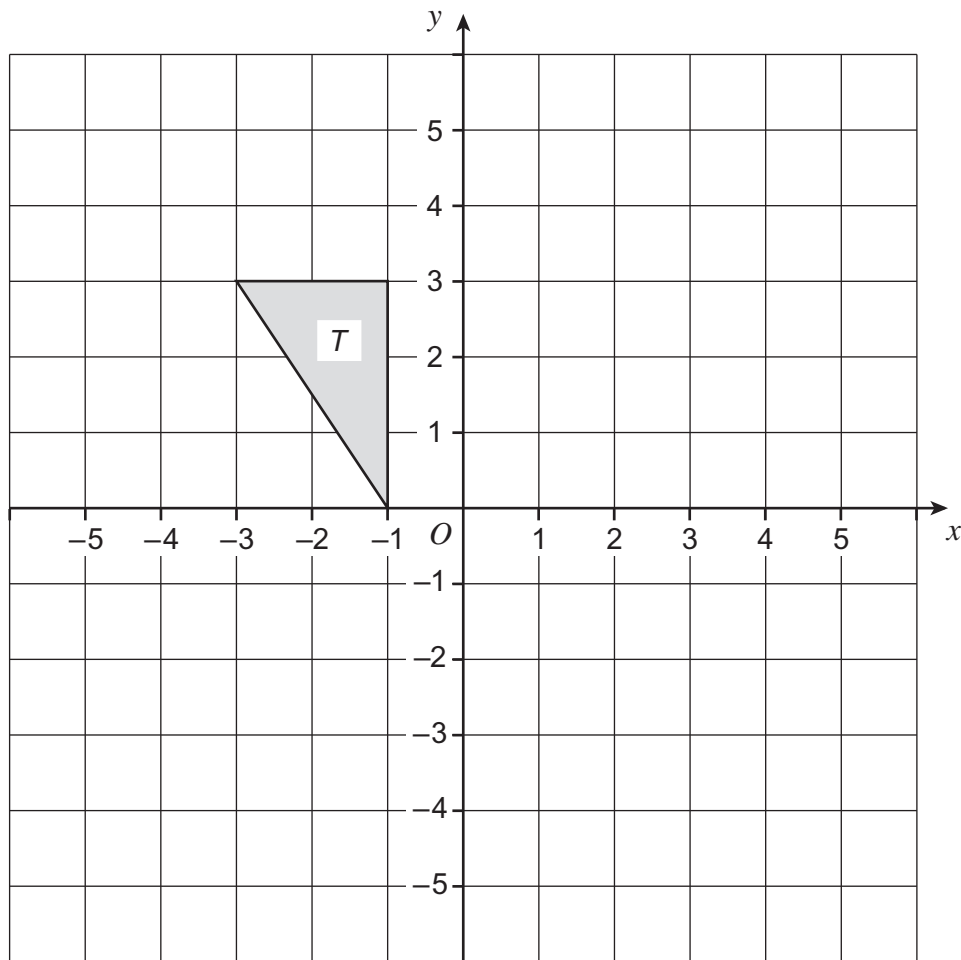

2 (b) Reflect triangle T in the line $y = -1$

[2 marks]

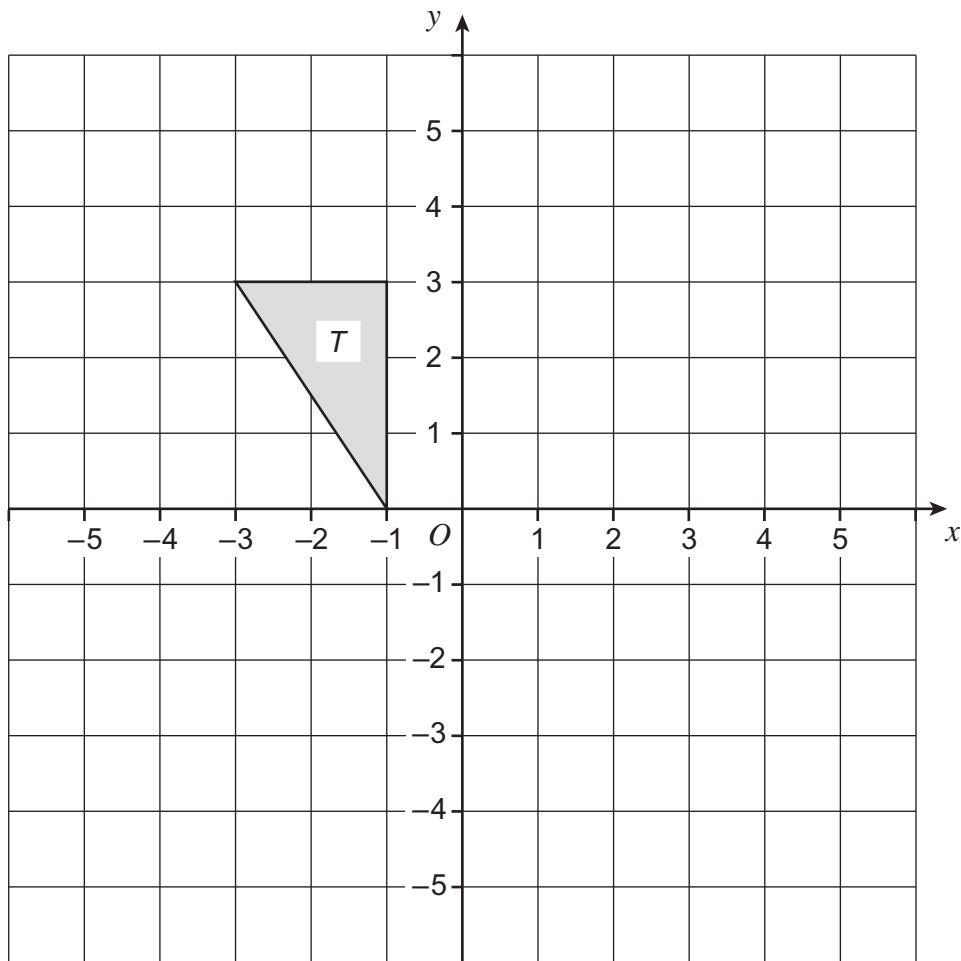

Turn over for the next question

Turn over ►



*3 A company claims the following miles per gallon for two cars.

Car A	68 miles per gallon
Car B	55 miles per gallon

The driver of car A
gets 30% **fewer** miles per gallon than claimed
and drives 15 000 miles.

The driver of car B
gets three-quarters of the miles per gallon claimed
and drives 12 000 miles.

Which driver uses more fuel?
You **must** show your working.

[5 marks]

.....

.....

.....

.....

.....

.....

.....

.....

.....

.....

.....

.....

.....

.....

.....

.....

.....

.....

.....

.....

.....

.....

Answer



4 A wheel has diameter 0.7 m

4 (a) Work out the circumference.

[2 marks]

.....

.....

.....

.....

Answer m

*4 (b) Work out the number of complete turns when the wheel travels 1.6 km
You **must** show your working.

[4 marks]

.....

.....

.....

.....

.....

.....

Answer

Turn over for the next question



- 5 The diagram shows a rectangle.

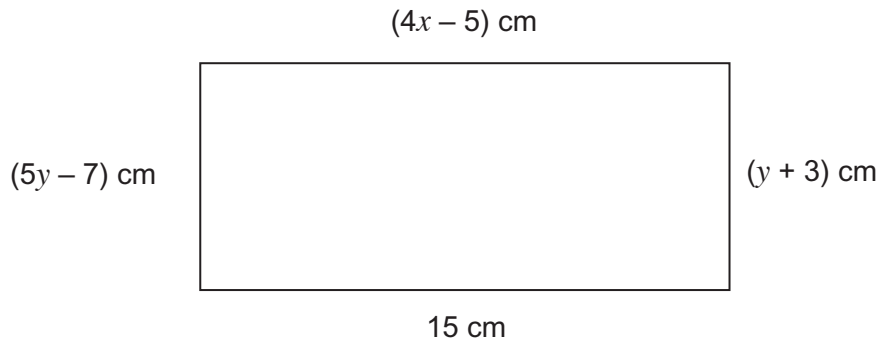

- *5 (a) Set up and solve an equation to work out the value of x .

[3 marks]

.....

.....

.....

.....

$x =$



5 (b) Work out the area of the rectangle.

[5 marks]

.....

.....

.....

.....

.....

.....

.....

.....

.....

Answer cm²

Turn over for the next question

8

Turn over ►



6 (a) The length of one side of a triangle is 10 cm

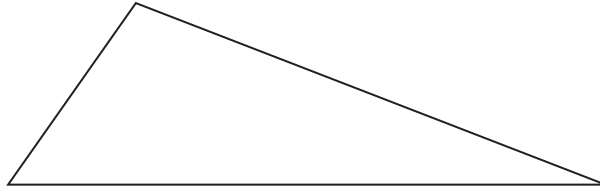

Not drawn
accurately

Tick the correct box for this statement.

The perimeter of the triangle is between 10 cm and 20 cm

[1 mark]

Always true

Sometimes true

Never true



6 (b) The length of one of the diagonals of a parallelogram is 10 cm



Not drawn
accurately

Tick the correct box for this statement.

The perimeter of the parallelogram is greater than 20 cm

[1 mark]

Always true

Sometimes true

Never true

Turn over for the next question

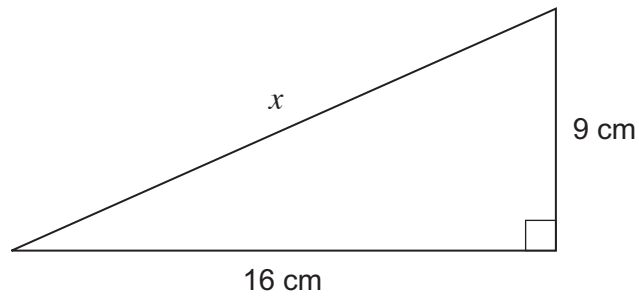

7

Not drawn
accurately

Work out the length x .
Give your answer to 1 decimal place.

[4 marks]

.....

.....

.....

.....

Answer cm



8 The diagram shows two buildings, A and B.

The heights of the buildings are in the ratio 3 : 5

Not drawn accurately

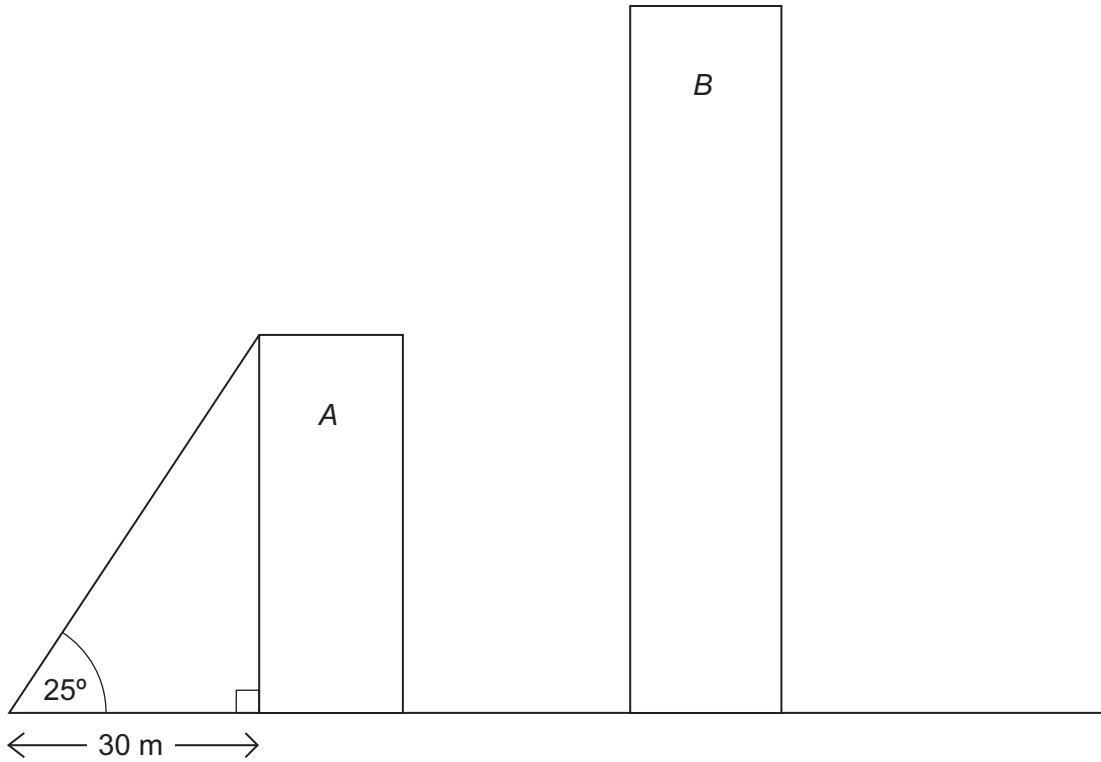

Work out the height of building B.

[4 marks]

.....

.....

.....

.....

.....

.....

.....

.....

Answer metres

8

Turn over ►



- 9 (a) AB is a chord of the circle.
 TA and TB are tangents to the circle.

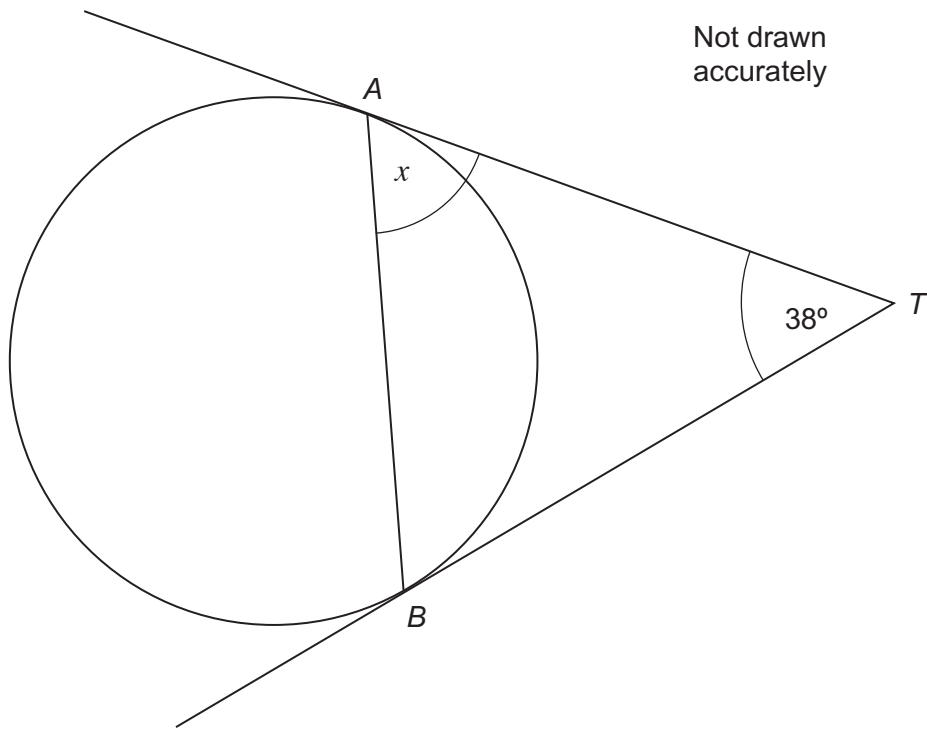

Work out the size of angle x .

[2 marks]

.....

.....

.....

Answer degrees



- 9 (b)** The diagram shows a circle, centre O .
 C and D are points on the circumference.
 COE is a straight line.
 DE is a tangent.

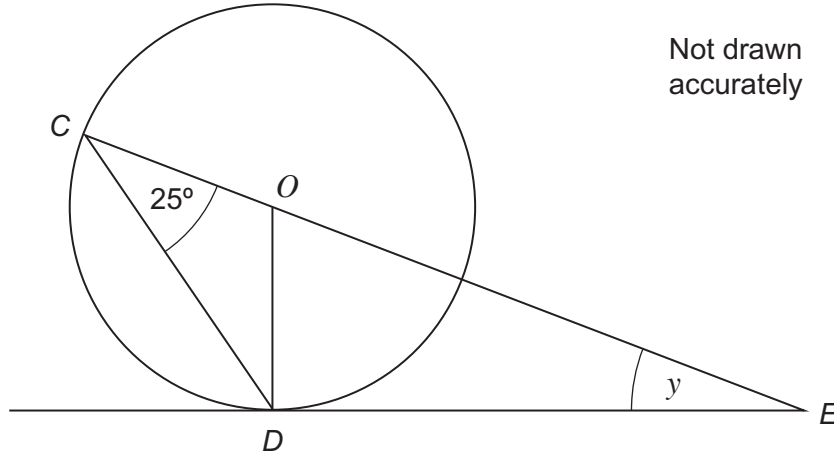

Work out the size of angle y .
 You **must** show your working, which may be on the diagram.

[3 marks]

.....

.....

.....

.....

.....

.....

Answer degrees

5

Turn over ►



- 10 The diagram shows a hollow steel girder in the shape of a prism.

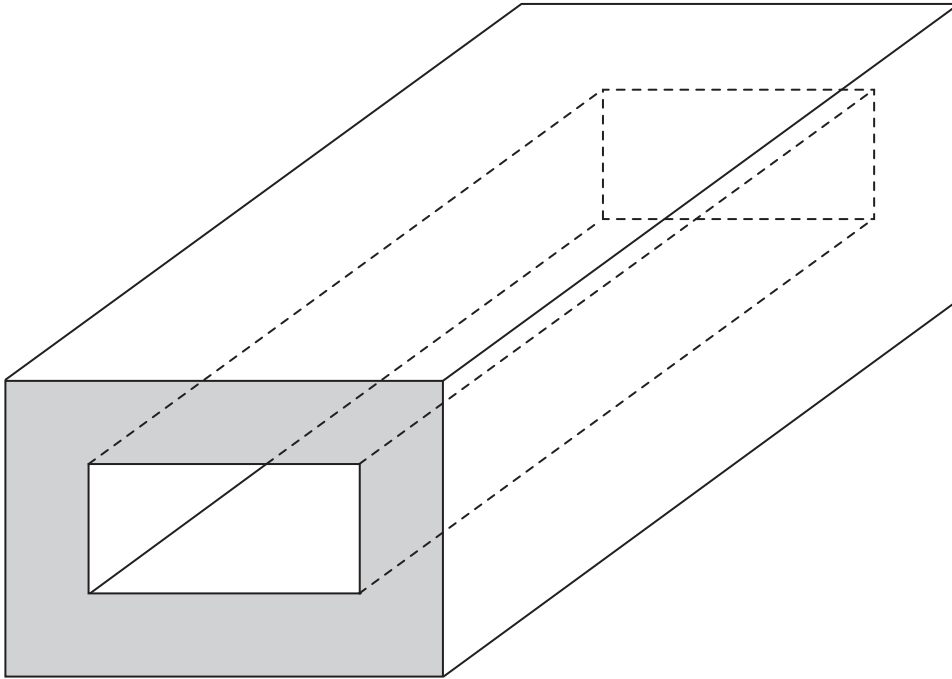

The diagram shows the dimensions of the cross-section.

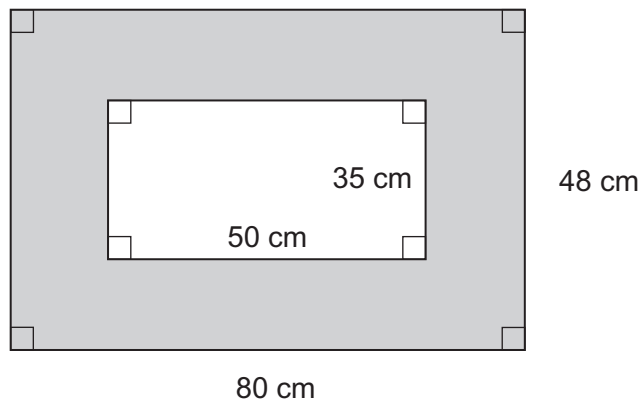

The length of the girder is 20 metres.

The density of the steel is 7.9 tonnes per cubic metre.



Work out the mass of the girder.

[4 marks]

.....

.....

.....

.....

.....

.....

.....

.....

.....

.....

.....

.....

.....

.....

.....

.....

.....

.....

.....

.....

.....

.....

Answer tonnes

Turn over for the next question

4

Turn over ►



11 (a) Complete the table of values for $y = x^2 - 6x + 9$

[2 marks]

x	0	1	2	3	4	5	6
y	9	4			1		9

11 (b) Draw the graph of $y = x^2 - 6x + 9$ for values of x from 0 to 6

[2 marks]

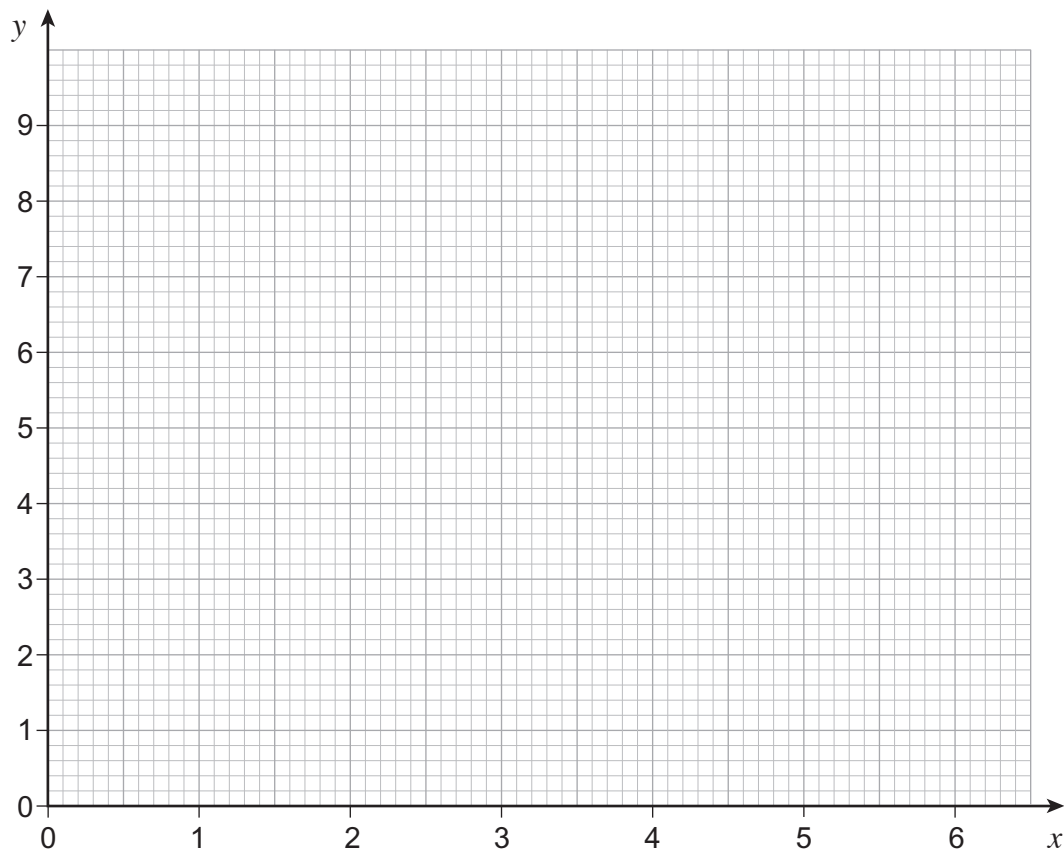

11 (c) Write down the solution of the equation $x^2 - 6x + 9 = 0$

[1 mark]

$x = \dots\dots\dots$



12 (a) These triangles are congruent.

Not drawn
accurately

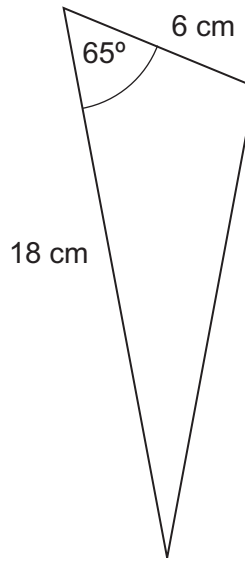
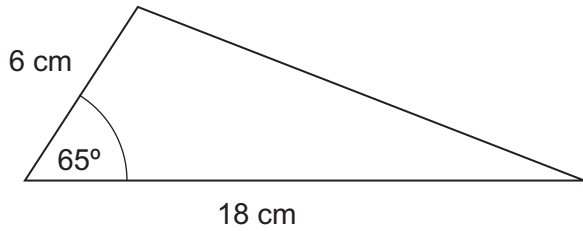

State the condition they satisfy.

[1 mark]

Answer

12 (b) These triangles are congruent.

Not drawn
accurately

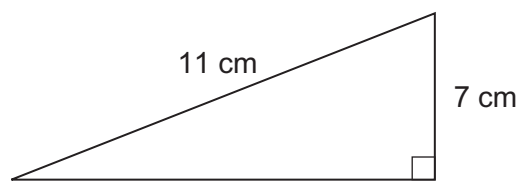
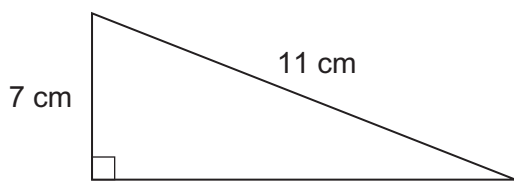

State the condition they satisfy.

[1 mark]

Answer

7

Turn over ►



13 The fare, £ y , for a journey is directly proportional to the square root of the distance, x miles.

13 (a) Which sketch graph represents this information?

Circle the correct letter.

[1 mark]

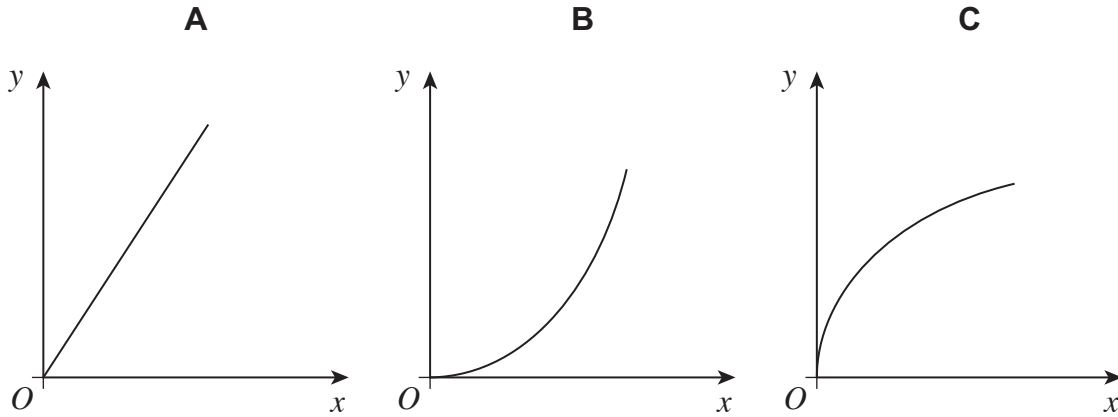

13 (b) A 100 mile journey costs £36

What is the cost of a 250 mile journey?
Give your answer to the nearest pound.

[4 marks]

.....

.....

.....

.....

.....

.....

.....

Answer £



14 The area of the triangle is 45 cm^2

Not drawn
accurately

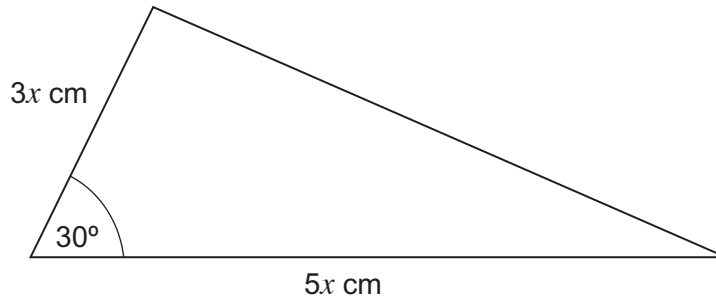

Work out the value of x .

[4 marks]

.....

.....

.....

.....

.....

.....

Answer

Turn over for the next question

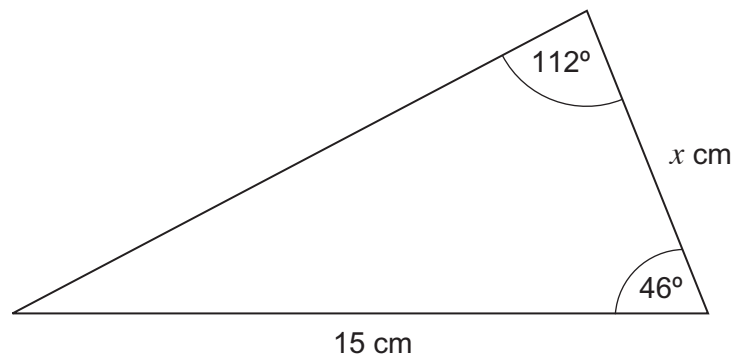

15

Not drawn
accuratelyWork out the value of x .**[4 marks]**

.....

.....

.....

.....

.....

.....

.....

.....

.....

Answer



16 Solve the quadratic equation $5x^2 + 8x + 2 = 0$

Give your answers to 1 decimal place.

[3 marks]

.....

.....

.....

.....

.....

.....

.....

.....

.....

.....

.....

.....

.....

.....

.....

Answer

Turn over for the next question

7

Turn over ►



- 17 $PQRS$ is a parallelogram.
 M is the midpoint of QR .
 $QN : NS = 1 : 2$
 $\vec{PQ} = \mathbf{a}$
 $\vec{PS} = \mathbf{b}$

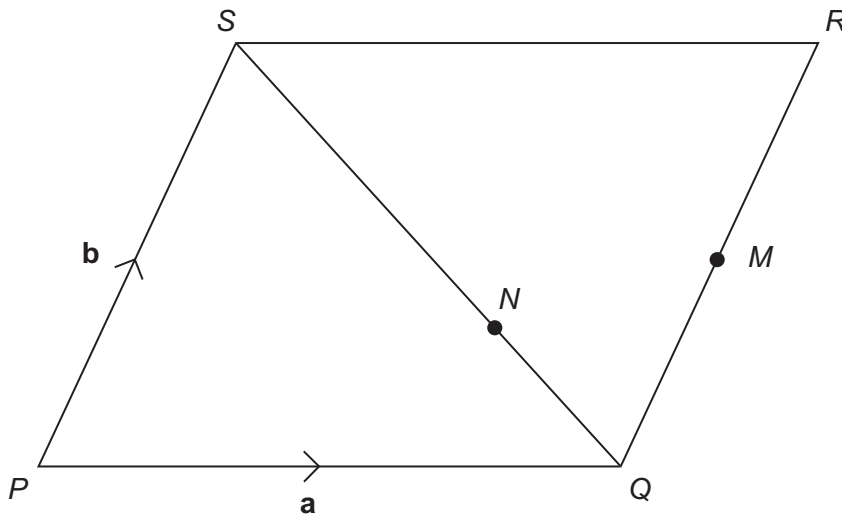

- 17 (a) Write the vector \vec{PM} in terms of \mathbf{a} and \mathbf{b} .

[1 mark]

.....

Answer



***17 (b)** Prove that PNM is a straight line.

[4 marks]

.....

.....

.....

.....

.....

.....

.....

.....

.....

.....

.....

Turn over for the next question

5

Turn over ►



18 The diagram shows a sphere, radius 6 cm, and a solid hemisphere, radius 9 cm

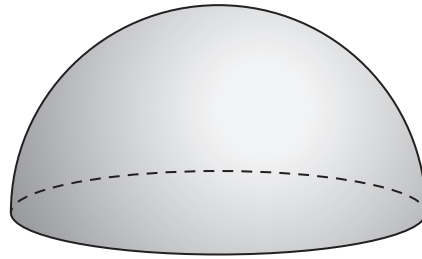
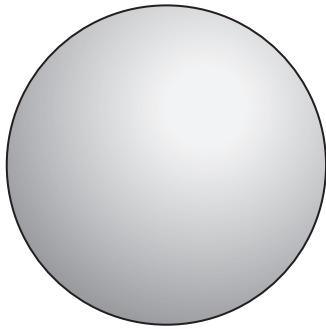

Work out the ratio

surface area of the sphere : **total** surface area of the hemisphere

Give your answer in its simplest form.

[5 marks]

.....

.....

.....

.....

.....

.....

.....

.....

.....

.....

.....

.....

.....

.....

.....

.....

.....

.....

.....

.....

.....

Answer :



19 The diagram shows an empty cone of radius 1.5 metres and height 4 metres.

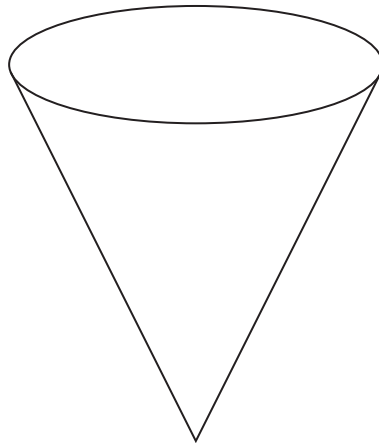

Sand is poured into the cone at a rate of 0.2 m^3 per minute.

Work out the number of minutes it takes to fill the cone.

[3 marks]

.....

.....

.....

.....

.....

.....

.....

.....

.....

.....

.....

.....

.....

.....

.....

.....

Answer minutes

END OF QUESTIONS



There are no questions printed on this page

**DO NOT WRITE ON THIS PAGE
ANSWER IN THE SPACES PROVIDED**

