

Centre Number						Candidate Number				
Surname										
Other Names										
Candidate Signature										



General Certificate of Secondary Education
Higher Tier
June 2014

Mathematics

43603H

Unit 3

Friday 13 June 2014 9.00 am to 10.30 am

H

<p>For this paper you must have:</p> <ul style="list-style-type: none"> • a calculator • mathematical instruments. 	
---	--

Time allowed

- 1 hour 30 minutes

Instructions

- Use black ink or black ball-point pen. Draw diagrams in pencil.
- Fill in the boxes at the top of this page.
- Answer **all** questions.
- You must answer the questions in the spaces provided. Do not write outside the box around each page or on blank pages.
- Do all rough work in this book.
- If your calculator does not have a π button, take the value of π to be 3.14 unless another value is given in the question.

Information

- The marks for questions are shown in brackets.
- The maximum mark for this paper is 80.
- The quality of your written communication is specifically assessed in Questions 6, 15 and 18. These questions are indicated with an asterisk (*).
- You may ask for more answer paper, graph paper and tracing paper. These must be tagged securely to this answer book.

Advice

- In all calculations, show clearly how you work out your answer.

For Examiner's Use	
Examiner's Initials	
Pages	Mark
3	
4 – 5	
6 – 7	
8 – 9	
10 – 11	
12 – 13	
14 – 15	
16 – 17	
18 – 19	
20 – 21	
22 – 23	
24 – 25	
26 – 27	
TOTAL	



J U N 1 4 4 3 6 0 3 H 0 1

Formulae Sheet: Higher Tier

Area of trapezium = $\frac{1}{2}(a+b)h$

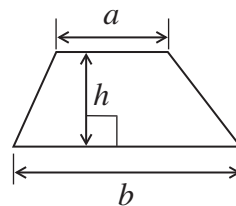

Volume of prism = area of cross-section \times length

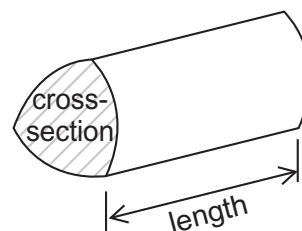

Volume of sphere = $\frac{4}{3}\pi r^3$

Surface area of sphere = $4\pi r^2$

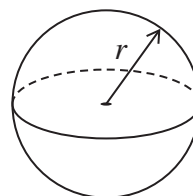

Volume of cone = $\frac{1}{3}\pi r^2 h$

Curved surface area of cone = $\pi r l$

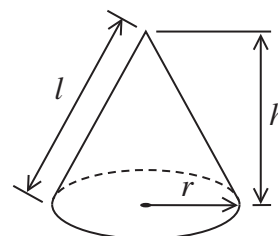

In any triangle ABC

Area of triangle = $\frac{1}{2}ab \sin C$

Sine rule $\frac{a}{\sin A} = \frac{b}{\sin B} = \frac{c}{\sin C}$

Cosine rule $a^2 = b^2 + c^2 - 2bc \cos A$

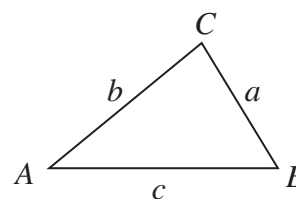

The Quadratic Equation

The solutions of $ax^2 + bx + c = 0$, where $a \neq 0$, are given by

$$x = \frac{-b \pm \sqrt{b^2 - 4ac}}{2a}$$



Answer **all** questions in the spaces provided.

1 This solid shape is made from identical cubes.

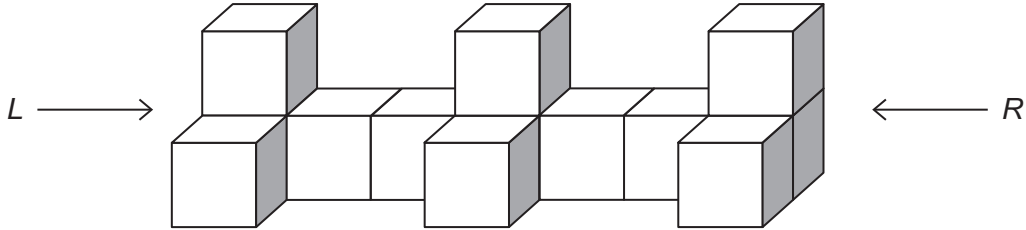

On the grids, draw the side elevations from *L* and *R* and the plan view.

[3 marks]

L

R

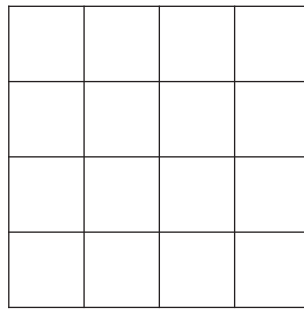
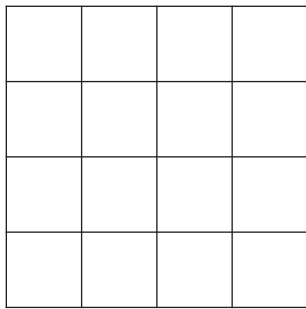

Plan view

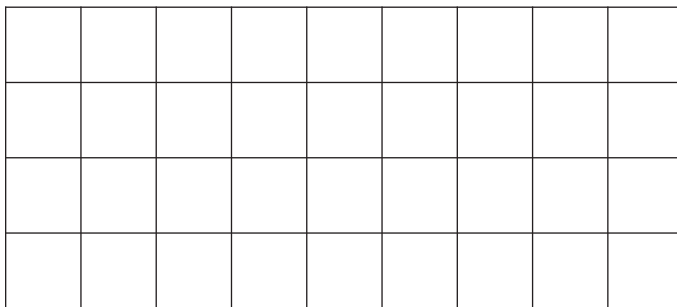

- 2 The diagram shows a full-size drawing of a drinking glass.
The glass is a cylinder with radius 3 cm and height 14 cm.

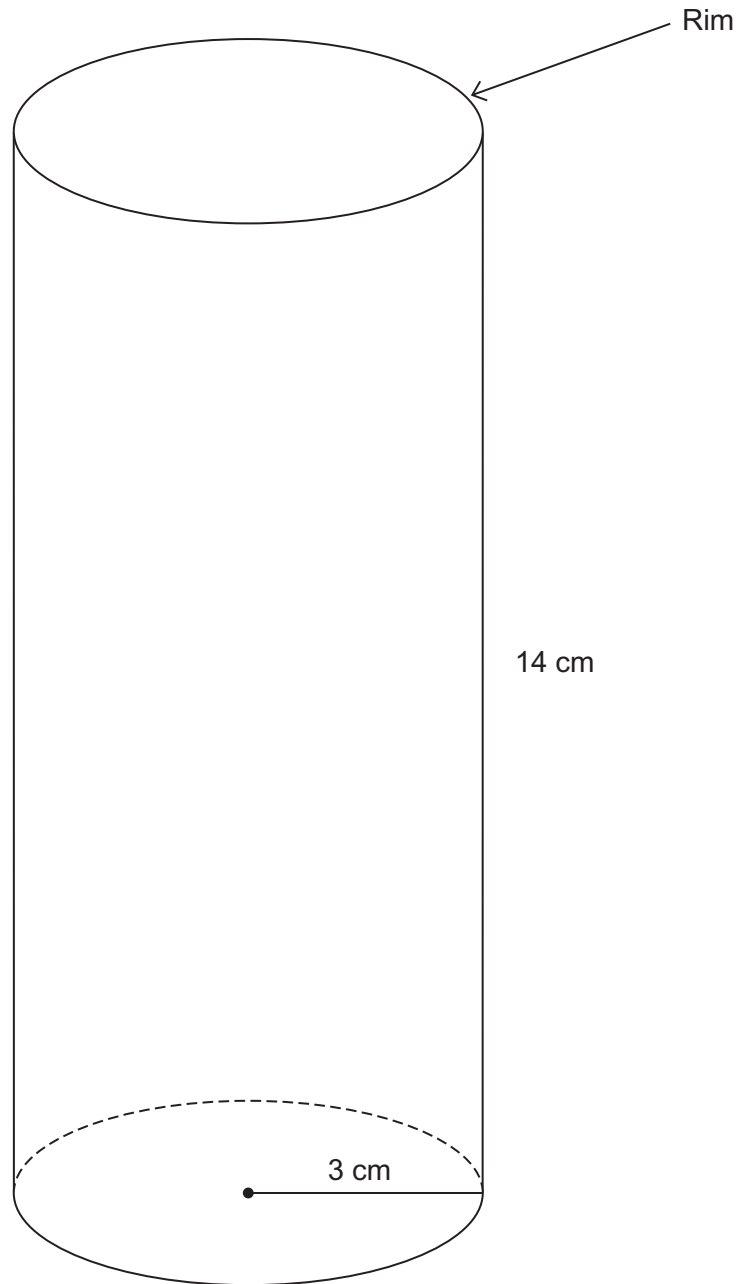

A man claims that the circumference of the rim is greater than the height of the glass.

Is he correct?

You **must** show your working.

[2 marks]

.....

.....

.....

.....

Answer

Turn over for the next question

2

Turn over ►



3 The diagram shows a triangle.

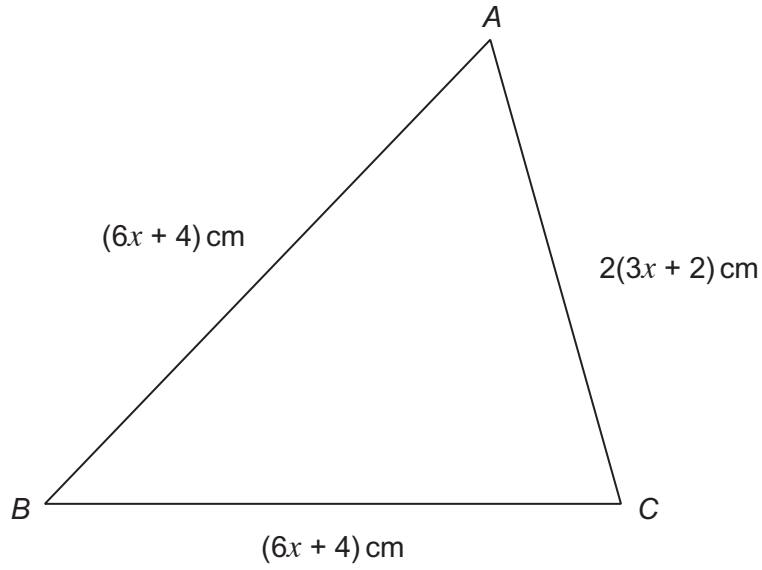

Not drawn
accurately

What type of triangle is it?
Give a reason for your answer.

[2 marks]

Answer

Reason

.....

.....



4

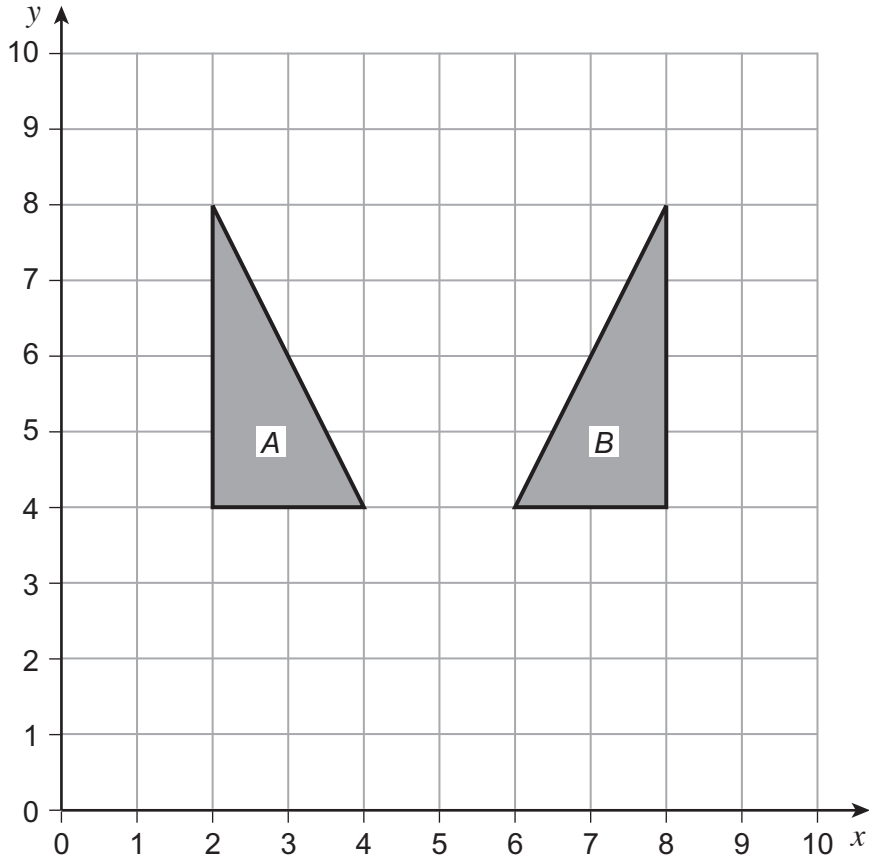

Describe fully the **single** transformation that maps shape A to shape B.

[2 marks]

.....

.....

Turn over for the next question

Turn over ►



5

Not drawn accurately

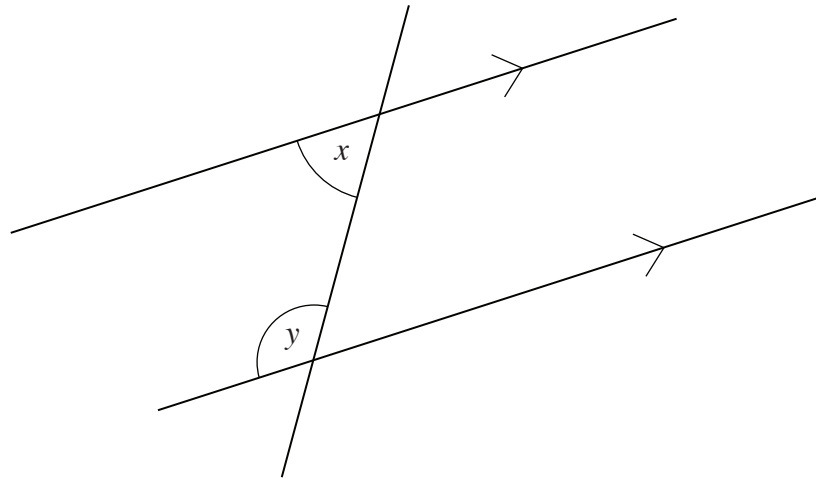

5 (a) Use the diagram to write an equation connecting x and y .

[1 mark]

Answer

5 (b) The ratio $x : y = 2 : 3$

Use this information to write another equation connecting x and y .

[1 mark]

.....
.....

Answer

5 (c) Work out the size of angles x and y .

[3 marks]

.....
.....

$x = \dots\dots\dots$ degrees, $y = \dots\dots\dots$ degrees



*6 This water tank is a cuboid.

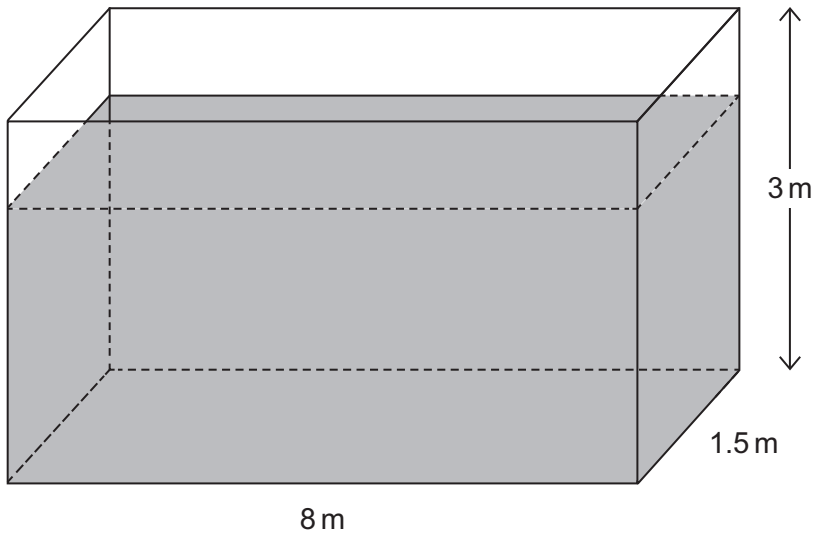

You are given that 1 cubic metre holds 1000 litres.

The tank is five-sixths full of water.

Water is leaking from the tank at a rate of 20 litres per minute.

How long will it take the tank to empty?

Give your answer in hours.

[5 marks]

.....

.....

.....

.....

.....

.....

.....

.....

.....

.....

Answer hours

10

Turn over ►



7 The diagram shows a map of Poland.



Choose one of the following three-figure bearings to complete each sentence correctly.

045°

090°

035°

180°

225°

270°

315°

360°

7 (a) The bearing of Krakow from Gdansk is [1 mark]

7 (b) The bearing of Gdansk from Poznan is [1 mark]



8

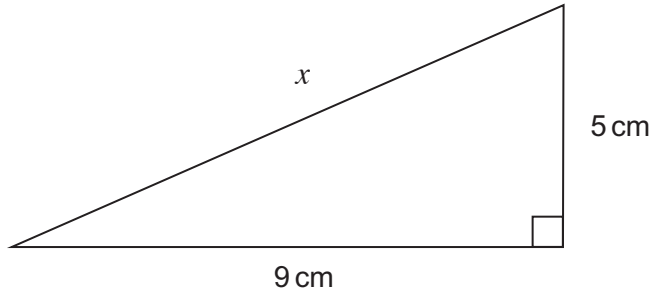

Not drawn
accurately

Work out the length x
Give your answer to 1 decimal place.

[4 marks]

.....

.....

.....

.....

Answer cm

Turn over for the next question

6

Turn over ►



- 9 An octagon is made by cutting four identical triangles from a square sheet of gold as shown.

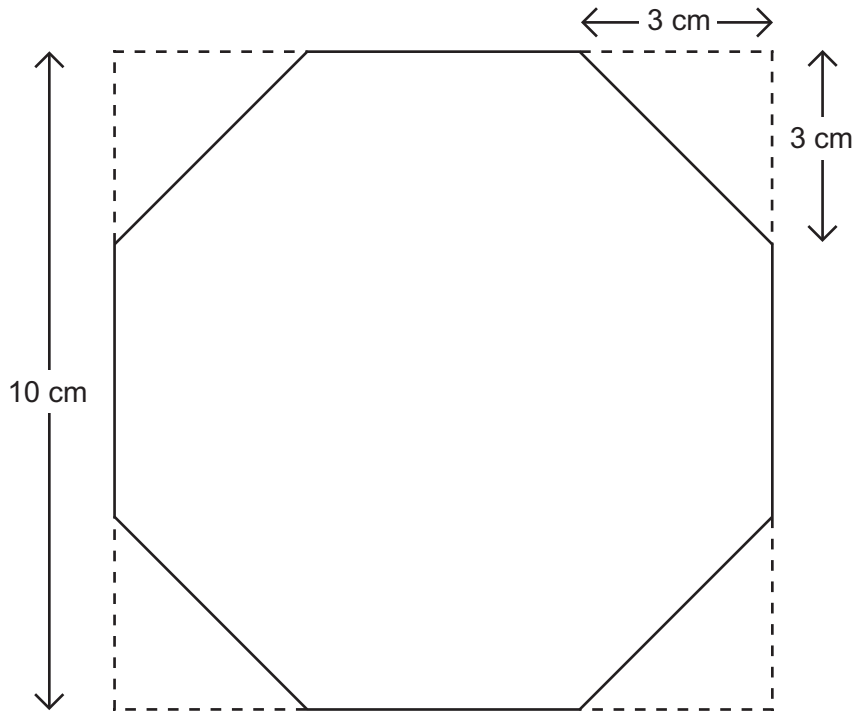

Not drawn
accurately

- 9 (a) Show that the area of the octagon is 82 cm^2 .

[4 marks]

.....

.....

.....

.....

.....

.....

.....

.....

.....



9 (b) The original square sheet of gold has a value of £750

The octagon shape is made into a piece of jewellery.
This increases the value of the gold in the octagon shape by 90%

Work out the new value of the gold in the octagon shape.

[4 marks]

.....

.....

.....

.....

.....

.....

.....

.....

.....

Answer £

Turn over for the next question



10

You will need a ruler and compasses for this question.

Draw accurately the locus of a point which is always 5 cm from the line.

[3 marks]

11 Circle the correct words to complete each sentence.

11 (a) $x^2 + 3x = 16$ is **[1 mark]**

an expression an equation a formula an identity

11 (b) $V = \pi r^2 h$ is **[1 mark]**

an expression an equation a formula an identity

11 (c) $(x + 3)^2 \equiv x^2 + 6x + 9$ is **[1 mark]**

an expression an equation a formula an identity

11 (d) $2x + 3y$ is **[1 mark]**

an expression an equation a formula an identity



- 12** The coordinates of four of the vertices of a cuboid are $(0, 0, 0)$, $(4, 0, 0)$, $(0, 6, 0)$ and $(0, 0, 10)$.

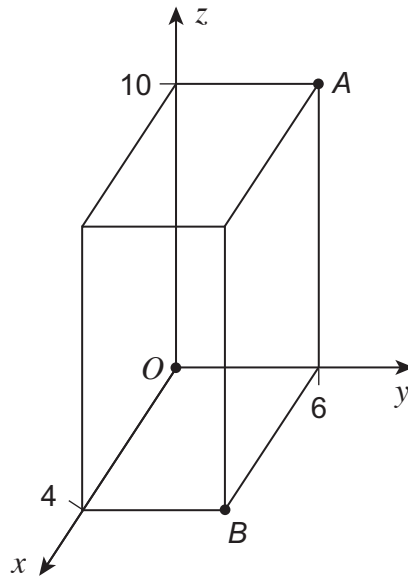

- 12 (a)** Write down the coordinates of vertex A .

[1 mark]

Answer (..... , ,)

- 12 (b)** Write down the coordinates of vertex B .

[1 mark]

Answer (..... , ,)



12 (c) Work out the total surface area of the cuboid.

[3 marks]

.....

.....

.....

.....

.....

.....

.....

.....

Answer square units

Turn over for the next question

5

Turn over ►



13 The diagram shows a square with area 100 cm^2

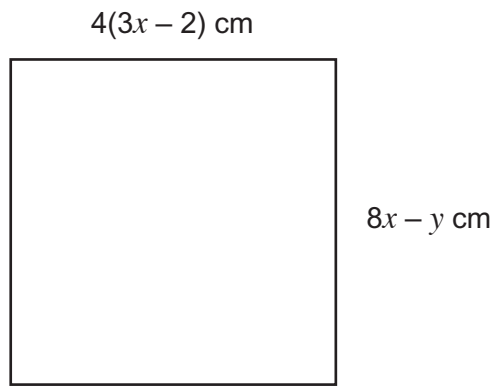

Not drawn
accurately

Work out the values of x and y .

[6 marks]

.....

.....

.....

.....

.....

.....

.....

.....

$x =$

$y =$



14

Not drawn
accurately

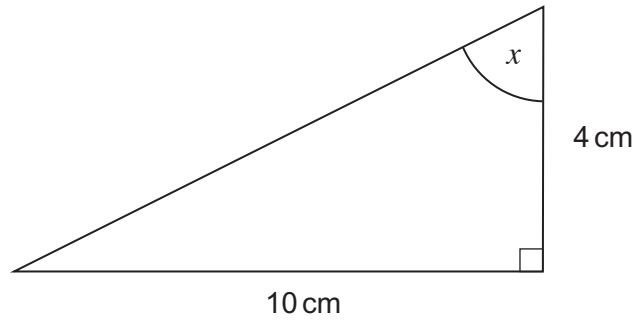

Work out the size of angle x .

[3 marks]

.....

.....

.....

.....

Answer degrees

Turn over for the next question



- 15 (a) The diagram shows a circle, centre O , with diameter AB .

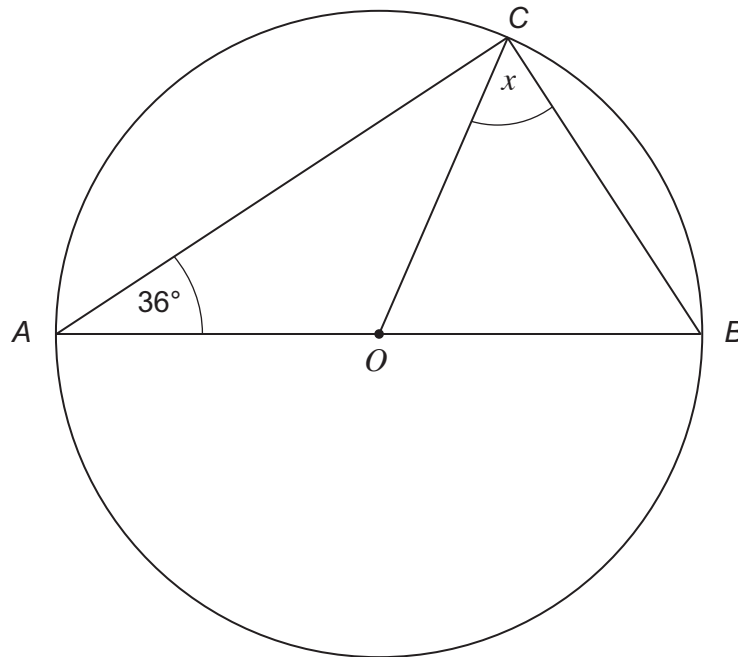

Not drawn
accurately

Work out the size of angle x
You **must** show your working, which may be on the diagram.

[2 marks]

.....

.....

.....

.....

Answer degrees



***15 (b)** The diagram shows a circle touching a square at A , B , C and D .

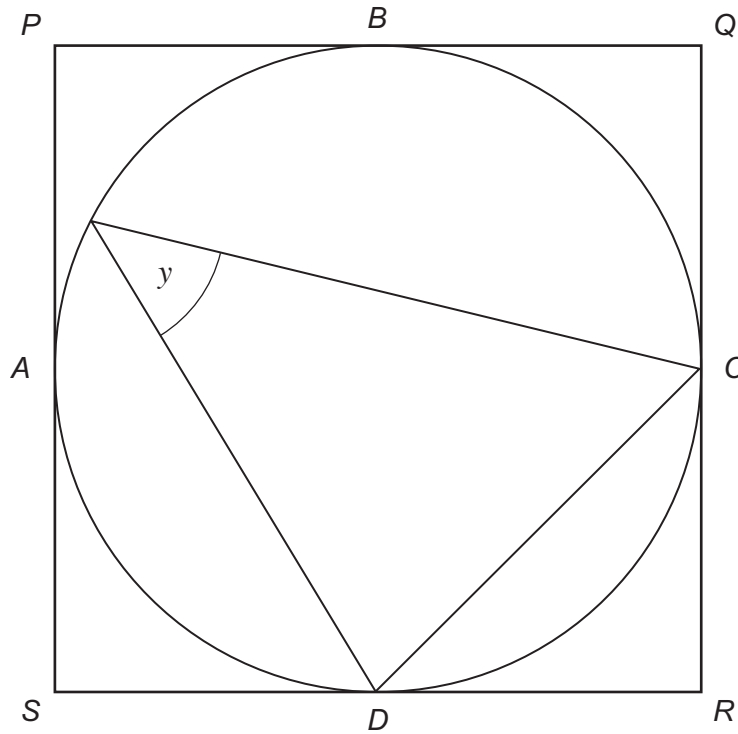

Not drawn
accurately

Give reasons to show why $y = 45^\circ$

[3 marks]

.....

.....

.....

.....

.....



16 (a)

Not drawn
accurately

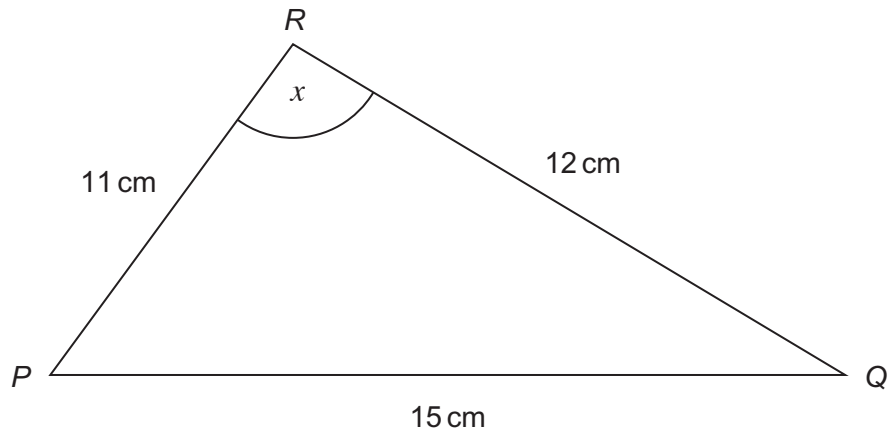

Use the cosine rule to work out the size of angle x .

[3 marks]

.....

.....

.....

.....

.....

.....

.....

.....

.....

Answer degrees



16 (b)

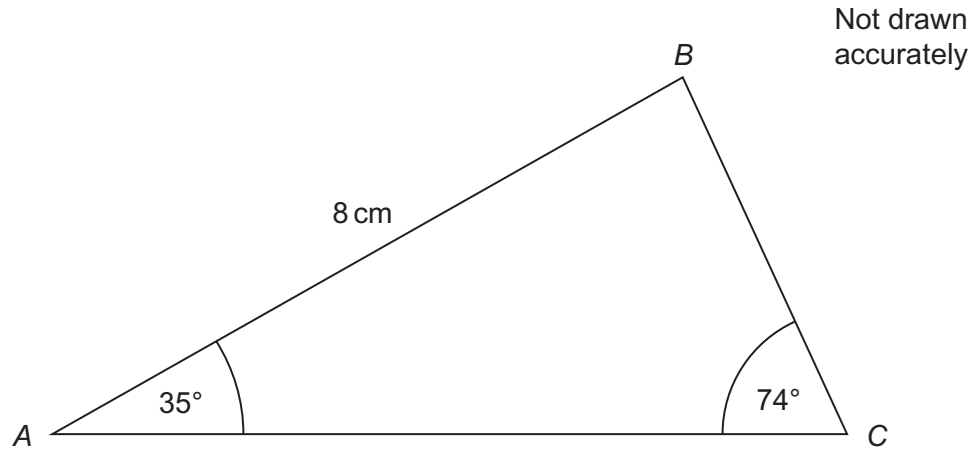

Use the sine rule to work out the length BC .

[3 marks]

.....

.....

.....

.....

.....

.....

.....

.....

.....

Answer cm



17 Solve the quadratic equation $3x^2 - 12x - 5 = 0$

Give your answers to 2 decimal places.

[3 marks]

.....

.....

.....

.....

.....

.....

.....

.....

.....

.....

Answer



***18**

This shape is made from two sectors and two squares of side 8 cm.
The radius of each sector is also 8 cm.

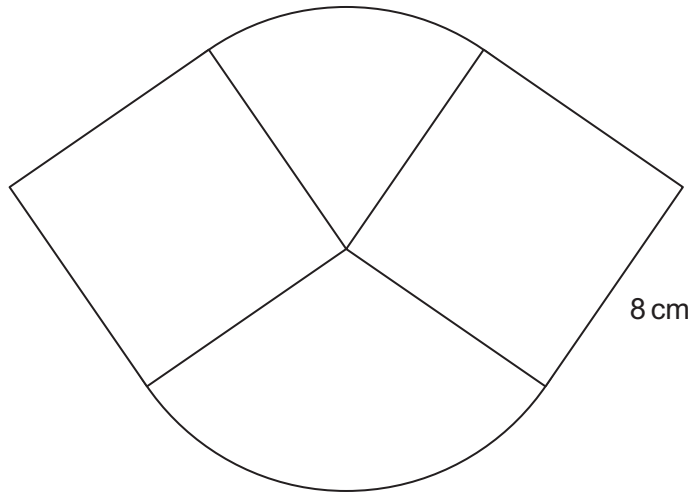

Not drawn
accurately

Work out the total area of the shape.

[4 marks]

.....

.....

.....

.....

.....

.....

.....

.....

Answer cm²

7

Turn over ►



19 A frustum is made by cutting a small cone from the top of a large cone as shown.

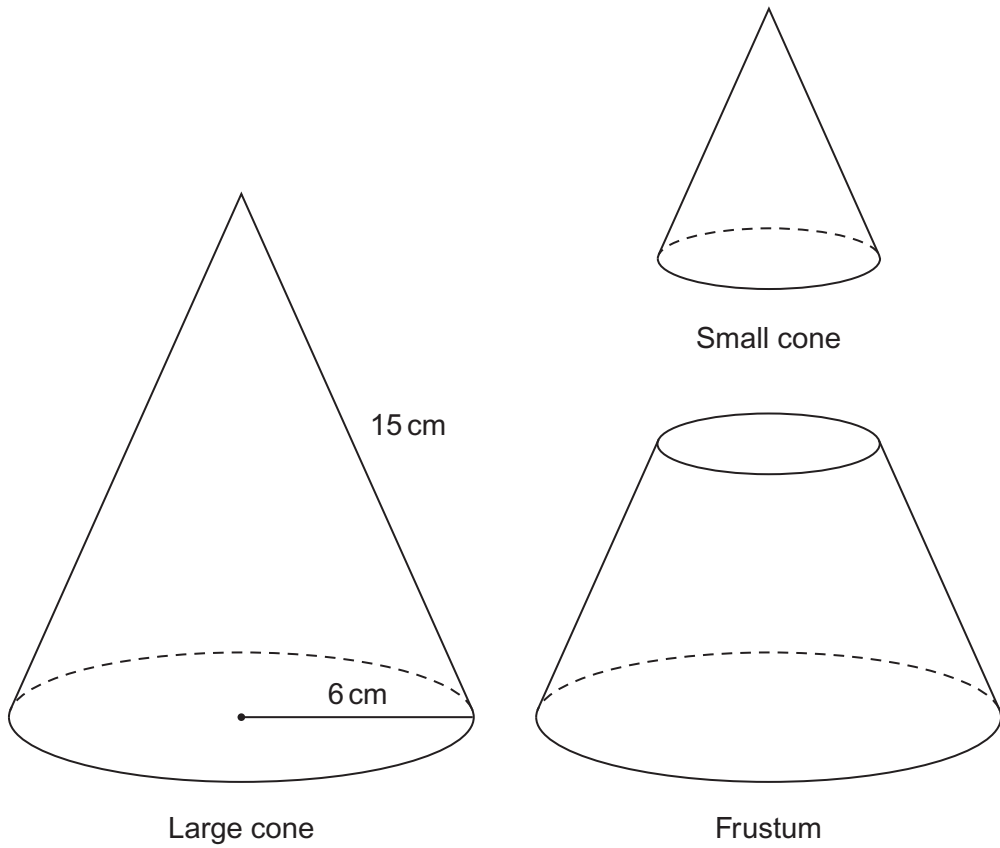

The slant height of the large cone is 15 cm.
The radius of the base of the large cone is 6 cm.

The height of the small cone is half the height of the large cone.

Work out the **curved** surface area of the frustum.

[4 marks]

.....

.....

.....

.....

.....

.....

.....

Answer cm²



20 (a) The diagram shows a sketch of the graph $y = x^2$

On the blank grid sketch a graph of $y = -x^2 + 2$

[2 marks]

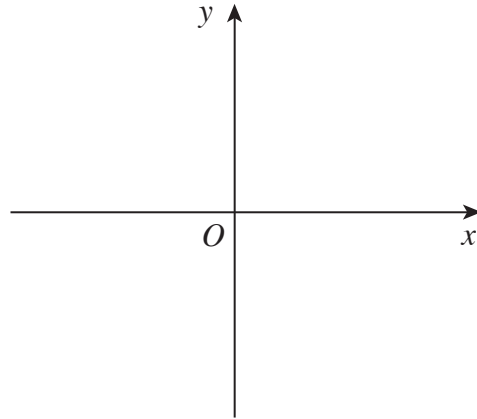
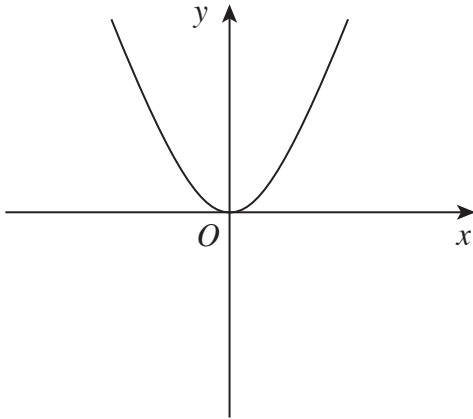

20 (b) This diagram shows a sketch of the graph $y = x^3$

On the blank grid sketch a graph of $y = x^3$ after a translation by the vector $\begin{pmatrix} -5 \\ 5 \end{pmatrix}$

[2 marks]

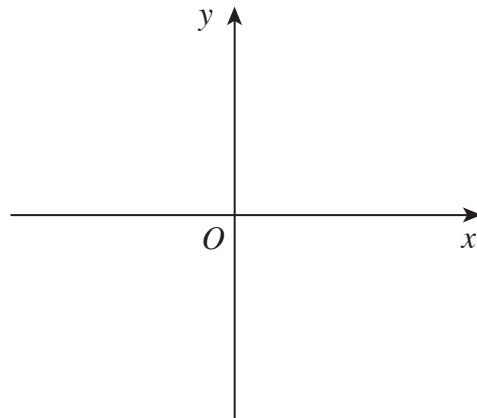
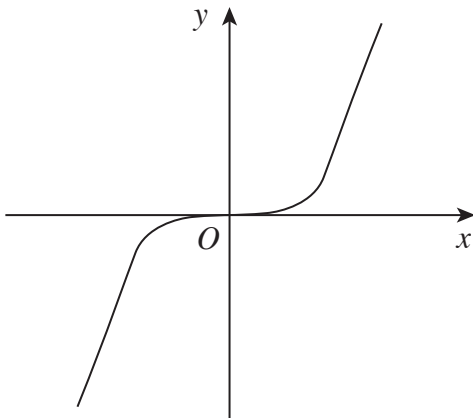

END OF QUESTIONS



There are no questions printed on this page

**DO NOT WRITE ON THIS PAGE
ANSWER IN THE SPACES PROVIDED**

